



ENGINEERING

SAFETY RULES & PROCEDURES

**Adopted by all North American Subsidiaries
of Genesee & Wyoming Inc.**

Effective 07/01/2018

THESE RULES AND PROCEDURES SUPERSEDE ALL PREVIOUS
VERSIONS OF ENGINEERING SAFETY RULES AND PROCEDURES.

RECEIPT

(Date)

NAME _____
(Please Print)

EMPLOYEE NUMBER _____

Received a copy of the Engineering Safety Rules and Procedures.

I understand, that I am required to have a thorough knowledge of and obey these rules while on duty, or on company property.

Conditions may arise which are not covered by a rule or instruction. Sound judgment must be applied to supplement these rules, but deviations from the rules are not permitted.

Signature of Employee

Issued by

Safety Policy Statement

This book provides rules and procedures that, when followed, will enable you to work safely and efficiently. At Genesee & Wyoming, safety is our number one concern and we are committed to achieving an injury-free environment for your workplace. To help with this effort, we endeavor to hire employees who share our commitment to create that environment.

You will find that most accidents do not just happen; they are caused. For that reason, we provide our employees with entry-level and ongoing training to help them learn and develop safe work practices. Many of those safe work practices are found in this book, but not all work situations can be anticipated and provided for in these rules. Therefore, it is always necessary to understand your job, to survey your work area for possible hazards, and to use sound judgment to minimize the risk of accidents and injuries. Additionally, you can confer with fellow employees or your supervisor and draw upon their experience to minimize hazardous situations you may be confronting for the first time.

At Genesee & Wyoming, we value excellence in everything we do. As part of our quest for excellence, all accidents and injuries will be thoroughly investigated to develop an understanding of the cause and to formulate steps to prevent a recurrence. You may be asked to participate in this process as required, and the lessons learned will be shared throughout the company.

Please remember, you have a big responsibility, not only to yourself but also to your fellow-workers. For this reason, we expect you to report to work free of any substance that may impair your on-the-job performance. In fact, we have in place a zero-tolerance policy concerning substance abuse in the workplace. Since safety is a concern to all employees, don't be afraid to correct any of your fellow employees working in an unsafe manner, and report any unsafe conditions immediately to the proper authority.

And last, remember, you play the major role in assuring that you end the day safely.

David A. Brown
Chief Operating Officer

NOTICE

Safety is of the first importance in the performance of duty. Obedience to the rules is essential to safety. These rules are effective May 01, 2017 and updated July 01, 2018 and replace any previous Engineering Safety Rules and Procedures on all regions within Genesee & Wyoming Inc.

These rules should be viewed as minimal guidelines and you are **encouraged** to make recommendations for changes or additions through your safety committee. In addition, manufacturers' recommendations and instructions shall be followed unless superseded by company rules or instructions which are more restrictive.

The safety rules in this book are grouped under headings for convenience. However, observe the applicable precautions wherever and whenever they relate in any way to the performance of your duties.

All employees affected by these rules must:

- (a) Obtain a copy from their supervisor;
- (b) Know the rules;
- (c) Understand their application;
- (d) Comply with the rules while on duty or on company property; and
- (e) Do everything in their power to prevent accidents and immediately correct any action of a co-worker not in compliance with the rules even though in doing so they may perform the duties of others.

When in doubt as to the meaning of any rule of instruction, employees must ask their supervisor for an explanation.

Supervisors will lead by example. Supervisors will hold regular job briefings to discuss applicable safety rules and collect feedback from employees. They will regularly observe work and provide the necessary assistance to ensure compliance with the safety rules. We need your help to make every day injury-free on Genesee & Wyoming.

Zero Injuries is always our Goal!

Ray Goss
Sr. Vice-President – Engineering

TABLE OF CONTENTS

SAFETY POLICY STATEMENT	4
NOTICE	5
GENERAL RULES	9
EMPLOYEE RESPONSIBILITIES	11
OTHER APPLICABLE RULES	11
GENERAL RESPONSIBILITIES.....	12
WALKING.....	13
ATTIRE AND PERSONAL PROTECTIVE EQUIPMENT	14
TOOLS AND EQUIPMENT	17
HAND TOOLS.....	17
POWER TOOLS	20
LIFTING AND RIGGING	22
HANDLING MATERIALS MANUALLY.....	27
PROTECTION AGAINST MOVING LOCOMOTIVES AND RAILCARS	28
WORKING WITH FLAMMABLES, EXPLOSIVES, ACIDS AND VAPORS	29
WORKING WITH ELECTRICAL APPARATUSES	30
PERFORMING SPECIFIC TASKS	34
GAS CUTTING AND WELDING.....	34
THERMITE WELDING	35
CUTTING A TREE.....	36
HEATING A RAIL WITH FUEL SOAKED MATERIAL	36
EXCAVATIONS	36
LADDER, SCAFFOLD, TRESTLE, AND WORKING AT AN ELEVATED PLACE.....	37
WORKING AT GRADE CROSSINGS	39
WORKING AROUND TRACKS AND EQUIPMENT	39
GENERAL RESPONSIBILITIES.....	39
ON OR NEAR WORK TRAINS	41
ROADWAY MAINTENANCE MACHINES AND HI-RAIL EQUIPMENT	42
OTHER EQUIPMENT	47
MOTOR VEHICLES	49
OPERATING SWITCHES	50
APPENDIX A MATERIAL WEIGHTS FOR LIFTING & TRANSPORTING CHART	52
Handling Materials with Grapples.....	57
Grapple Types	58
APPENDIX B CHAIN SAW USE DECISION MATRIX	59
APPENDIX C SAFETY RULE CALENDAR	60

TERMS AND DEFINITIONS

TERM	DEFINITION
Braced Position	A standing position with feet set apart to resist movement, using a handhold if possible.
Clear of Tracks	At least four feet outside the rail of all tracks, and not between main tracks.
Close Clearance	Any obstruction (structure, object or condition) adjacent to, overhead or converging with a track that will not permit the normal and clear passage of train movements on the track, including anyone riding on such movements. There are two basic types of close clearances: permanent structures and temporary or unexpected obstructions.
Confined Space	Any space that has limited openings for entry or exit, unfavorable natural ventilation that could contain or produce dangerous air contaminants, or a deficiency of oxygen and is not intended for continuous occupancy.
Dusts	Created when solid material breaks down and gives off the particles that float in the air before settling by gravity. Dusts are produced by operations such as grinding, crushing, drilling, blasting, sanding, and milling.
Firm Footing	A stance with feet flat and firmly on the ground, equipment, or other level place. For firm footing on a stirrup or rung, place your heels against the outside edge, when space permits; otherwise, turn your foot slightly sideways.
Fumes	Created when solids or liquids vaporize under high heat. The metal vapor cools and condenses into an extremely small particle. Fumes can come from operations such as welding, smelting and pouring of molten metals.
Handhold	A firm grip with both hands, when possible, on a handrail or other stationary support.
Hoisting Equipment	Any kind of apparatus (crane) that exerts a force for lifting or lowering, whether fixed or mobile, driven manually or by power.
Immediate Supervisor	A person in charge of the work being performed.
Personal Protective	Devices tested and approved for a specific purpose

Equipment (PPE)	and designed to safeguard an individual against hazards.
Qualified	An employee who has been trained, tested and has demonstrated to representatives of his or her department the ability at a task during a designated period.
Safety Appliances	Stationary handholds, ladder rungs, crossover platforms are some examples. These features are designed for safety.
“3 Step” Protection	A procedure followed by train and engine employees used to protect employees prior to fouling equipment. When protection is requested, the Engineer must take three actions: <ol style="list-style-type: none"> 1. Apply the train or engine brakes. 2. Place the reverser lever in neutral position. 3. Open the generator field switch.
Three Points of Contact	Contacting equipment with feet placed firmly and using firm handgrips (two hands & one foot or one hand & two feet).
Track	Term designating the area between rails and an area that extends to 4 feet outside each rail.
Track car	Equipment (other than trains) operated on track for inspection or maintenance.
Track center	Distance from the center of one track to the center of an adjacent track.

GENERAL RULES

1. If an employee notices any unsafe act or condition at any time while on GWI property and property served by GWI, while either on or off duty, it is the employee's responsibility to take whatever immediate action necessary to prevent loss or injury resulting from such condition, and then to immediately report the unsafe act or condition to a company supervisor. Warn all other persons in the immediate area of the condition to avoid their contact with the unsafe condition.
2. Good housekeeping is essential; therefore, ALL EMPLOYEES are responsible to keep work areas orderly and clean.
3. Promptly remove all refuse to the designated location or receptacle. Hazardous materials must be handled and disposed of in accordance with G & W Environmental Policies and Guidelines and applicable laws.
4. Keep clear of any area contaminated with hazardous material. Only qualified and trained personnel are to enter such an area after an emergency situation has ended. Wear the appropriate protective clothing and respirator as designated by your immediate supervisor. If you have come into contact with hazardous substances, you must wash before eating, drinking, or smoking. Report any contact with hazardous materials to your immediate supervisor.
5. Never eat, drink, or store food or beverages in any area exposed to toxic material.
6. Do not use drinking water containers for any other purpose. All containers should be used as intended.
7. If practical, keep at least 50 feet (15.2 m) from passing trains or equipment to avoid protruding, dragging or falling objects.
8. Inspect passing trains and if dangerous conditions are detected, use any available means to advise the crew members on the passing train to stop.
9. Attempt no work that will interfere with the safe passage of trains.
10. Employees must not use tools, machinery or appliances that are improperly assembled, defective or improvised, and must not use them for other than their intended purpose. It is your personal responsibility to examine any tool, equipment, or other item for defects before using it. Report any defect to your immediate supervisor.
11. When using any tool or item, you must;
 - (a) Place your feet firmly
 - (b) Maintain a braced position - don't overreach
 - (c) Keep your hands and other body parts clear of pinch points
12. Protect the point of any pointed tool when it is in or about your clothing.
13. When handling sliding or hinged devices, use handles or knobs if provided. Properly secure the device before placing any portion of your body into an opening. Do not open more than one filing or tool cabinet drawer at a time. Immediately close devices and drawers carefully upon completion of the task.

- 14.** You must not perform any act that defeats the purpose of a safety device such as an electrical fuse, circuit breakers, or pressure valve.
- 15.** Before operating a control lever, push button, switch, or other control device, confirm to the extent practical that all persons who might be affected are in the clear.
- 16.** Keep clear of and do not face any welding, cutting, heating, or grinding operation without appropriate eye protection, hearing protection, face shield and proper clothing.
- 17.** Keep clear of any suspended load. Stand clear while tension is applied (through either a pull or a lift) to a cable, chain, or other tackle.
- 18.** You must not operate or ride on any type of equipment except as necessary in the performance of your duties.
- 19.** Do not start or stimulate a fire in a stove, furnace, or other source of open flame by using grease, flammable liquid, or any material saturated with a flammable liquid. Those fuel oil stoves, designed to be started by an open flame, are the only exception.
- 20.** Flammable gases, liquids, or solids must not be stored near a pilot light, open flame, or other source of open heat or light.
- 21.** Never use gasoline or any other flammable liquid for cleaning. Immediately remove and dispose of gloves or clothing that becomes saturated with a combustible substance, keeping a safe distance from any source of heat or open flame.
- 22.** Water must not be used to extinguish a fire on or near electrical equipment, circuits, or apparatus. The proper fire-extinguishing agent is to be used when fighting fires.
- 23.** To avoid electrocution, keep at least twelve feet away from a dangling wire or any object that may be in contact with an electrical current. Keep others away until a qualified person is notified and takes charge.
- 24.** You must use safety belts or harnesses where and when required.
- 25.** Do not jump from platform, or other elevated location. If necessary to descend without a ladder or steps, you must:
 - (a) Observe the ground or floor condition and avoid holes, slippery spots or obstructions; then,
 - (b) Assume a sitting position with your legs hanging over the edge to decrease the distance to the ground while maintaining a handhold on a suitable object, if available; and, slowly descend in a manner that both feet contact the ground at the same time.
- 26.** Do not throw or intentionally drop any item.

EMPLOYEE RESPONSIBILITIES

OTHER APPLICABLE RULES

In addition to the rules presented in this book, the applicable portions of the following, with any other applicable or subsequent instruction, must be observed.

- Air Brake and Train Handling Instructions
- CWR Maintenance and Installation Policy*
- Daily Bulletins (DOB)
- Environmental Policy
- Fall Protection Program
- Federal, Province, State, or Local Laws and Regulations
- General Orders*
- Hazardous Material Policies, Procedures and Regulations.
- Hearing Conservation Program
- Human Resources Employee Handbook
- Lockout/Tagout and Energy Isolation Policy
- Office Safety Rule Book
- Railroad Timetable*
- Railroad Operating Rules*
- Railroad Vehicle Backing Procedure
- Respirator Fit Test and Respirator Selection Guide
- Roadway Worker, Roadway Maintenance Machine, and On-Track Safety Rules*
- **Hazard Communication Program**
- **Personal Protective Equipment (PPE) Program**
- **All other documents required by regional or railroad management**

* Need to be maintained in one manual and available while on duty (On-Track Safety Manual). Other items from this list may be added to the On-Track Safety Manual when applicable.

The Hearing Conservation Program, Respirator Fit Test and Respirator Selection Guide, Hazard Communication Program, Personal Protective Equipment (PPE) Program and be found of the Safety Department site on the company intranet.

GENERAL RESPONSIBILITIES

- 8000.** You must use care to prevent injury to yourself and others. You must be alert and attentive at all times when performing your duties and plan your work to avoid injury, which includes a job safety briefing. Only do work for which you are qualified.
- 8001.** You must protect your own safety. Do not rely on others, when you have the ability to protect yourself.
- 8002.** Conduct a job briefing at the beginning of and throughout the workday. **Job briefings must be documented on an approved paper form by everyone at a job location.** Remain alert of your surroundings and anything out of the ordinary. Report suspicious activity to your supervisor or dispatcher immediately.
- (a) Conduct a job briefing:
- 1) Before beginning a work activity.
 - 2) When the work activity or conditions change.
 - 3) When another person or piece of equipment joins the crew.
 - 4) When required to handle hand operated switches in controlled track.
 - 5) After lunch or after a prolonged delay in the work activity.
- (b) When conducting a job briefing:
- 1) Discuss the sequence of job steps.
 - 2) Discuss the Roadway Worker Track Protection.
 - 3) Discuss emergency procedures and locations of first aid kits, fire extinguishers, and automated external defibrillators (AED).
 - 4) Identify, eliminate, contain, and/or communicate all potential hazards. **If the risks associated with a task significantly increase the likelihood or potential severity of injury, stop, consult supervision as required and develop alternative methods or procedures to reduce the risks.**
 - 5) Inspect tools and equipment before use.
 - 6) Identify proper PPE for the job task.
 - 7) Ensure understanding of the planned sequence of events.
 - 8) Follow up to ensure compliance with safe work practices.
- 8003.** While on duty you are prohibited from using either personal or company-provided, cell phones while driving for any purpose other than placing or receiving a call with a voice-activated (hands-free) device.

Employees are strictly prohibited from using other portable electronic devices any time while driving company vehicles, and while driving personal vehicles for company business or any other travel that has a connection to work with Genesee & Wyoming Inc. or its subsidiaries. Portable electronic devices include hand-held mobile telephones, hand-held devices with mobile data access, personal digital assistants, laptop computers or other portable computing devices, pagers, text message devices, electronic games, broadband personal communication devices and global positioning systems (GPS).

- 8004.** Do not use personal or company-provided cell phones or electronic devices for communication in the foul of the track. If practical, do not use such devices within 30 feet (9 m) of the foul of any track or roadway.
- 8005.** For any incident, you must immediately:
- (a) Obtain first aid or medical attention if necessary.
 - (b) Inform your immediate supervisor as soon as possible.
 - (c) Follow proper reporting procedure of injuries or human factor incidents.
- 8006.** Immediate supervisors should:
- (a) Be responsible for the safety, instruction and performance of all the employees under their jurisdiction and inform supervision of all injuries and incidents.
 - (b) Define work assignments.
 - (c) Personally and continuously supervise work involving unusual hazards and discuss the specific procedures to protect against them.
 - (d) Provide coaching to improve employee's work practices. Notify supervisors or employees who do not improve after coaching.
- 8007.** Employees must not:
- (a) Sleep or assume the attitude of sleep.
 - (b) Read books, magazines or newspapers other than job related material.
 - (c) Use unauthorized audio or video devices.
 - (d) Use electronic devices that may interfere with job responsibilities and safety.
 - (e) Engage in any activity which is not directly associated with your duties.
 - (f) Scuffle, play practical jokes, or conduct horseplay while on duty or on company property.
 - (g) Use or possess firearms or other weapons while on duty or on company property.
 - (h) Be tardy, absent, or derelict of duties. Report for duty at the appropriate time and location ready for work.
- 8008.** Know the location of first aid kits, lifesaving and firefighting equipment and use that equipment only for the purpose intended.
- 8009.** Do not interfere with signal apparatus, signal system, or signal equipment unless qualified to do so.
- 8010.** Non-employees and contractors must follow the rules as if employees.
- 8011. Portable derails must be locked and secured when not in use.**

WALKING

- 8030.** When walking:
- (a) Do not run and face the direction in which you are moving.
 - (b) Do not place your feet where your eyes have not viewed.
 - (c) Keep your hands out of pockets.
 - (d) Do not jump across ditches, excavations, holes or open pits.
 - (e) Do not walk and use electronic devices at the same time.

- (f) Do not place your foot on any part of a rail, frog, switch point, guard rail, or switch machine unless required to complete task.
- (g) Have sufficient light to permit moving about and performing work safely.
- (h) Keep all walkways free of any obstruction or slipping hazards. Clean the areas or use salt, sand, or other suitable material to increase traction. If cleaning is not practical, wear anti-slip footing.

8031. When walking through a hall, passageway or on stairways, follow these safety measures:

- (a) Keep to the right.
- (b) Use handrail whenever provided.
- (c) Use each step of a stairway.
- (d) Exercise caution when going around a corner to prevent a collision with a vehicle or person.
- (e) Give way to persons with a heavy load.
- (f) Use care when passing doors that open directly into the passageway.

ATTIRE AND PERSONAL PROTECTIVE EQUIPMENT

8050. When using Personal Protective Equipment:

- (a) Inspect the equipment prior to use.
- (b) Wear the equipment in the manner intended.
- (c) Do not alter or modify.
- (d) Replace defective PPE immediately.
- (e) See PPE Matrix for needed PPE for each job task.
- (f) PPE is not required in the following locations when not involved in work activities:
 - Lunchroom
 - Locker room
 - Inside vehicles
 - Inside railway passenger cars
 - Offices
 - Other areas as designated by the Regional V.P. – Engineering

8051. Do not wear head or facial hairstyles that obscure vision, interfere with the proper fit of personal protective equipment, or may contact machinery or electrical equipment.

8052. Outside of an office environment employees must wear at minimum:

- (a) Trousers or pants that cover your legs.
- (b) Waist length shirts with at least a ¼ length sleeve. **Longer sleeves are required during certain work activities. Refer to rule 8059.**
- (c) Clothing should not be ripped, torn, or tattered.
- (d) Clothing should not have inappropriate logos or phrases.
- (e) Clothing should be sufficient to protect against wind chill or heat exposure.
- (f) Safety Toed footwear **covering the entire foot constructed of leather,**

leather-like, or ballistic Kevlar at least 6 inches (15.25 cm) high with ANSI class 75-toe protection. **Must be lace up with** a definite heel no more than 1½ inches (3.8 cm). **Must have non-slip puncture proof soles with no metal or cleat plates. Approved spiked over-boots must be used during times of snow or ice.**

8053. Do not wear:

- (a) Finger rings outside of an office environment.
- (b) Jewelry or accessories that could become entangled in equipment.
- (c) Mouth and tongue jewelry.
- (d) Metal watchbands when repairing or maintaining electrical equipment.

8054. All employees are required to wear approved high-visibility work wear when they are on duty or on the company property. Such high-visibility work wear must be worn as the outermost layer of clothing.

(a) **High visibility apparel must be approved by the Safety Staff, must conform with the ANSI/ISEA 107-2015 performance standards for Class 2 and 3 apparel and may consist of a vest, coveralls, t-shirt, or other clothing of prescribed color, (normally yellow/green or orange), and equipped with the minimum amount of retro-reflective striping as follows: a horizontal band around the waist, an “X” on the back, and two vertical bands in the front from the waist to the top of the shoulders. Stripes must be of silver or yellow retro-reflective material and be at least 2 inches (5 cm) in width. Additional retro-reflective striping added to the garments is allowed providing that the overall design of the garment meets the ANSI/ISEA 107-2015 criteria.**

(b) Vests must be properly sized and constructed with tear-away features.

8055. Wear appropriate safety eyewear that is clean and properly fitted. Z87 and AO+ is the minimum standard. If you require corrective lenses, you must wear prescription safety glasses with approved side shields, **safety glasses designed to be worn over prescription glasses** or cover-all type goggles over your personal glasses. Approved safety goggles will be used in lieu of safety glasses when the potential for work conditions to expose employees to debris that could enter the eyes. Clear glasses must be worn in low light conditions.

8056. An approved hardhat must be worn when on duty, on company property, in shop areas, or other locations required by your immediate supervisor. Hardhats must be worn as intended by design. Additional headwear must be designed to be worn under hardhats. Bump caps are permitted only when working in areas of severely reduced space.

8057. Wear approved hearing protection when operating or working within 50 feet (15.2 m) of any equipment, machinery marked with a warning label, power tools, or at locations posted or requiring its use. Hearing protection must also be worn when striking metal with metal (spiking, applying or removing rail anchors, etc.).

8058. Wear an approved respirator prescribed by the Respiratory Protection Program Respirator Selection Guide.

8059. Wear the appropriate PPE for your job task. Refer to the PPE chart below:

Engineering PPE Chart - Additional PPE Above and Beyond Basic PPE Requirements	Hearing Protection (plugs or Muffs)	Leather Gloves	Welding Gloves	Welding Jacket or Sleeves	Welding Helmet	Welding Pants	Tinted/Shaded Goggles	Chemical Protective Apron	Chemical Protective Apron	Plastic Face Shield (solid)	Wire Mesh Face Shield ANSI Z87.1 rating (6" tall min.)	Leather, Kevlar, or Ballistic Nylon Chaps	Leather Legging with Metatarsal (Foot) Guard	Metal Legging with Metatarsal (Foot) Guard	Respiratory Protection Program (respirator selection guide)
X = Required Personal Protective Equipment * = Recommended Personal Protective Equipment															
Basic PPE includes approved safety glasses with fixed side shields, lace-up, safety-toed boots, and hard hat.															
Bump caps are only allowed for mechanics in working in tight locations.															
If safety goggles are required, they can be worn in place of safety glasses when worn with a face shield.															
High visibility apparel is not required when working inside a shop or office environment.															
Kneepads may be used when kneeling for extended periods.															
Adze - Hand Operated		X									X			X	
Adze - Walk Behind	X	X								X		X			X
Adze - Powered with Enclosed Cab	X														
Ballast Unloading / Dumping		X													X
Banding Material Handling		X									X				
Bridge Work - Welding / Cutting / Grinding	X		X	X	X	X	X			X					X
Cadwell Welding			X							X					
Chain Saw	X	X									X	X			
Cutting/Burning with Torch	X		X	X		X	X						X		
Cutting/Burning Overhead or Out of Position	X		X	X		X	X			X					
Chemical Handling (Battery / Caustic)								X	X	X					X
Grinder - Handheld / Maul / Slotter	X	X		X						X			X		X
Grinder - Portable Rail	X	X								X			X		X
Grinder - Stationary in Shop (Bench Grinder)	X	X								X					X
Other Hydraulic, Electric, Pneumatic, or Gas Power Tool Not Listed on Chart	X	X								*					
Metal on Metal Striking (spiking, drift pins, applying rail anchors, etc.)	X	X									X				
Rail Saw	X	X								X			X		X
Thermite Welding			X												
Weed Eater or Other Powered Landscape Tool	X	X									X				
Hand Held Brush Axe or Machette		X		X							X				
Welding - Electric or Gas	X		X	X	X	X									X
In Vicinity or Roadway Maintenance Machines	X	*													

CONFINED SPACE

- 8070.** Do not enter a confined space such as storage tanks, manholes, culverts, pits, excavations or other areas where vapors and/or poor ventilation may be present unless trained and qualified under the confined space program.
- 8071.** If qualified to enter a confined space, do so only after the air quality has been monitored by the Entry Supervisor and the appropriate engineering controls, such as ventilation, have been established in accordance with the following:
- (a) Place suitable guards around the opening, such as temporary railings, barricades, or high visibility tape.
 - (b) Lockout/Tagout any machinery in the confined space as necessary.
 - (c) The air shall be continuously monitored during all activities when employees are inside the confined space. If ventilation does not control the air quality, cease operations and contact your supervisor and the Respirator Program Administrator for further instructions.
 - (d) Station an Attendant at the entrance of the confined space. The Attendant is not to leave their position until all of the work within the confined space is complete and there are no longer any employees inside the confined space.
 - (e) Maintain communication between the Attendant and the person inside the confined space at all times.
 - (f) If you experience dizziness, headache, or a rapid heartbeat, return to open air by immediately exiting the confined space all together.

TOOLS AND EQUIPMENT

HAND TOOLS

- 8080.** Always use the proper tool for the task and inspect tools before they are used looking for metal chips, cracks, or other defects. If defective, do not use them. Separate them from serviceable tools and equipment and mark them with a “DEFECTIVE-DO NOT USE” tag.
- 8081.** Place tools safely into storage. Store tools neatly so that you can safely remove them.
- 8082.** Stay a minimum of 10 feet (3 m) clear of swinging hand tools and the item being driven unless other employees are engaged in the actual work being carried out. This 10 foot (3 m) zone is the minimum amount required and should be increased, if necessary, to protect other employees from potential flying debris. Before swinging any tool, inform others nearby of your intention and make sure that they are in the clear.
- 8083.** Hammers, spike mauls, **and other tools** that will be used for striking **spikes, drift pins, rails anchors, or other track components** will be made out of Alloy B grade steel. Spike mauls will only be used to drive spikes.

- 8084.** When using tools, place your feet firmly and maintain a braced position. Do not overreach. Keep your hands and other body parts clear of pinch points.
- 8085.** When you are using a sharp or pointed tool, turn the edge away from your body, if possible. Disassemble or protect sharp edge or point when you are transporting them. Protect a tool by covering the point or edge with a cover designed for the tool. Place the point or edge of a tool down when you are not using it.
- 8086.** Do not use a drift pin, handle punch, cutter, spike lifter or similar tool unless it is equipped with a rubber grommet on the end being struck. Spike lifters must also be equipped with a shield to protect against broken spike heads.
- 8087.** Follow these precautions when using a rail fork:
- (a) Before you apply the rail fork, free any rail or switch point that is embedded in dirt or ballast or is otherwise wedged.
 - (b) If you have doubts about being able to control the rail (due to the weight or situation of the rail), use more than one rail fork.
 - (c) Make sure that you are in a braced position and have a firm grip on the end of the handle.
 - (d) If you are on track, keep your feet clear of the backward movement of the rail.
- 8088.** To use a hand adze, follow these steps:
- (a) Make sure that the object to be adzed is secure. Do not use your foot to secure the object.
 - (b) Remove nails, dirt, stones and other obstructions from the object.
 - (c) When possible, straddle the object. Be careful when swinging the adze between your legs.
 - (d) Use a short stroke
 - (e) When practical, cut with the grain. When cutting against the grain or through a knot, control the blade to prevent it from glancing.
 - (f) If you need to remove a large amount of material, notch and chip out pieces.
 - (g) Keep the adze head free of wood chips.
- 8089.** To use a bar or lever, follow these steps:
- (a) Place it securely under or against the object. If necessary, use a suitable block under the bar, lever, or raised object.
 - (b) Take a braced position with firm footing. Do not sit on, stand on, or straddle the bar or lever. Make sure that all parts of your body are positioned so that they will not be caught between the bar or lever and any other object (pinch points).
 - (c) Grip the bar or lever securely and move it slowly and steadily.
 - (d) Watch the base and contact points as you move the bar or lever and make necessary adjustments to maintain a secure bite.
 - (e) Do not extend the bar to gain more leverage.

8091. When operating a jack, follow this procedure:

- (a) Keep your hands clear of moving parts of the jack. Inspect the jack base for cracks. Do not position any part of your body under a load supported by a jack.
- (b) Place the jack straight up and down, unless the jack is being used to line track. In that case, place the jack sideways. Set the jack securely with solid contact at top and bottom, using suitable blocking under the jack when the foundation is insecure. Position the jack securely so that it will not slip at the base or at the object being lifted.
- (c) Never use more than one wood block between the jack head and the load. To raise the jack, use sound wood blocks under the jack, stacked in a way that they will not slip.
- (d) Use only the handle designed for the jack being used. Make sure the handle is fully inserted in the socket, and remove the handle when jack is not being used. Stand to the side when using the handle, maintain a braced body position. Move the handle slowly and uniformly making sure the latches are engaged.
- (e) Use only a jack with sufficient lifting capacity required for the job. When using a ratchet jack, stand at the side of the handle in a braced position. Move the handle slowly and uniformly, making sure that latches are fully engaged and that your head is clear of the handle when releasing pressure on it.
- (f) Before you lower a jack under load, **make sure all affected employees are clear and announce “All Clear.” Before operating the lowering mechanism, announce “Jack Down.”**

8092. When using a wrench, follow this procedure:

- (a) Select the proper size and type of wrench to fit the object. **“Speed” type track wrenches are not to be used.** Adjust the wrench to fit the object tightly. Do not use a shim to make the wrench fit.
- (b) If the wrench is an adjustable one, place it so that the turn will be in the same direction as the open end of the jaws. Do not immediately apply full force. Rather, make sure the wrench has a proper grip, and make sure the stroke of the wrench will not harm you. Then gradually increase the force, pulling the wrench toward you if possible.
- (c) Never push a wrench. Pull it with smooth steady force.

8093. Never use your finger to determine if a hole is in proper alignment for the insertion of a rivet, bolt, pin or other object. Use a drift pin or other suitable item.

8094. Follow these precautions when driving, starting and pulling a spike:

- (a) Do not allow more than one person to drive the same spike at the same time.
- (b) Do not bend or straighten a spike by placing it on the rail or tie and striking it.
- (c) Remove any loose objects from the top of the tie plate and tie within one foot of the spike.

- (d) Strike light blows until the spike is firmly seated and stable enough that it will not slip or jump when you strike hard blows.
- (e) Do not straddle a rail, stand to the side of the rail while swinging.
- (f) When pulling a spike with a claw bar, place your hands below the crook on the claw bar so that they will not be caught on a platform, girder, rail, or other object when the bar moves downward.
- (g) Place the claw end of the bar firmly under the head of the spike.
- (h) Do not strike a claw bar.
- (i) Make sure that all persons are clear of the claw bar.
- (j) Stand in a braced position. Begin with light pulls on the claw bar and gradually increase the force of each pull.
- (k) If a spike will not pry up easily, use a sledge hammer and a spike lifter.

POWER TOOLS

- 8100.** When power tools are available, they are to be used instead of using hand tools to complete work.
- 8101.** Inspect power tools **prior to use**. Power tools must not be operated if in unsafe condition. If defective, separate them from serviceable tools and equipment and mark them with a “DEFECTIVE-DO NOT USE” tag.
- 8102.** To operate powered tools you must:
- (a) Be qualified on the use of the tool.
 - (b) Follow manufacturer’s instructions on safe operation of the tool.
 - (c) Keep objects clear of the moving parts of power tools.
 - (d) Make sure that the safety devices and guards are in place and properly adjusted.
 - (e) If a power tool has a control switch, move it to the off position before you connect or disconnect the tool.
 - (f) Do not carry or lay down a portable power tool while it is operating. Hold the tool stationary until all moving parts have stopped. *Exception: You may carry a weed or brush cutter while it is operating.*
 - (g) When a tool is not in use, place it so that the trigger, valve, or switch cannot be activated accidentally.
 - (h) Hold the handle of a power tool firmly. Brace yourself and be prepared to move clear if the tool sticks or jams. Make sure that the material you are working on will not shift.
 - (i) Before you operate a power tool, warn others in the immediate area that you intend to use the tool and make sure they move to a safe position.
- 8103.** Follow these precautions when performing maintenance on a power tool:
- (a) Follow energy isolation and lock-out/ tag-out procedures.
 - (b) Do not use your hand to remove waste or obstructions from a tool. Use a brush or other suitable item.
 - (c) If you use compressed air to clean a power tool, make sure the pressure does

not exceed 30 psi. Do not use compressed air to clean a person or clothing.

- 8104.** Electrical power tools must have grounded connections or must be double insulated. Extension cords must match the rating and wiring of the tools for which they are used.
- 8105.** When fueling gasoline powered tools do so only when the engine is cool and not running, in safe areas, away from possible sources of fire.
- 8106.** When using a chain saw, follow the procedure below:
- (a) **Refer to Chain Saw Use Decision Matrix in appendix B to determine if the use of a chain saw is allowed with the situation at hand.**
 - (b) It is recommended that whenever possible more than one person be present when a chain saw is to be used.
 - (c) Inspect the saw before use to assure that all handles and guards (including kickback guard) are in place and tight, that all controls function properly, and the muffler is operative.
 - (d) Before you start the saw, check the area where you are going to be cutting. Clear away brush that might interfere with cutting.
 - (e) Start the saw at least 10 feet (3 m) away from fueling area. Make sure the saw is firmly supported on the ground or a stable object. Do not use your body as support. Do not drop-start the saw.
 - (f) Be certain of your footing before you start to cut and make sure to have a clear route of exit free of debris.
 - (g) Hold the saw with both hands during operation. Be alert for nails or other obstructions in the wood while you are cutting so as not to cut into them.
 - (h) Do not use the saw to cut directly overhead or at a distance that would require you to relinquish a safe grip on the saw.
 - (i) Carry the saw by the top section of the handle with the cutter bar to the rear.
 - (j) **Chain saws must be inspected and serviced annually by a professional chain saw shop.**
- 8107.** When using grinders and abrasive saws, observe the following procedures:
- (a) Grind only on the grinding face of a grinding wheel.
 - (b) Apply steady pressure to avoid damaging the wheel.
 - (c) Make sure grinding and cutting wheel being used is matched to the RPM requirements of the grinder/saw. Verify grinder and abrasive saw RPM with a tachometer daily before use.
 - (d) When using a portable grinder, first turn the switch or trigger to the “ON” position. Place the wheel against the material or object to be ground after it has reached maximum RPM in a gradual manner. When the work is completed or it is necessary to remove the wheel from the material or object, first turn the switch or trigger to the “OFF” position.
 - (e) Be aware of the sparks generated when using a grinder. Make sure others are not in an area of spark discharge. Be aware of fire potential.
 - (f) Never repair a grinder yourself. Only authorized repairmen may make such repairs.

- (g) Do not expose a stored or mounted grinding wheel to water, solvents, oil, or extreme temperatures. Follow manufacturer's specifications for proper storage. Do not leave grinding wheels on the tool when the tool is being stored.

8108. When using hydraulic tools:

- (a) Do not carry a hydraulic tool by the pigtail hoses.
- (b) Be aware that a hydraulic tool presents an oil injection hazard. Oil injection is a condition in which the hydraulic oil is forced under the skin through pressure in the line. Always wear gloves and repair leaks immediately.

8109. Do not use your fingers to dislodge a spike, even if the tool is not connected to a power source. There may still be pressure in the tool that could cause sudden movement of the jaws. Instead follow the following procedure for dislodging a spike:

- (a) Move the lever to the "OFF" position.
- (b) Disconnect the hydraulic hoses.
- (c) Activate the trigger to relieve pressure
- (d) Use vise grips or pliers to remove the spike.

LIFTING AND RIGGING

8120. Prior to use, inspect the crane and the hoisting equipment including chains, slings, cables, sheaves, hooks or other attachments and safety devices. Cranes, lifting chains and slings are to be inspected annually by an OSHA certified inspector. Records of the inspection must be kept on file. If defects are discovered remove from service and place a "DEFECTIVE-DO NOT USE" tag.

8121. When operating a crane or boom:

- (a) Use fully extended outriggers on all sides of the equipment. **If outriggers cannot be fully extended, reposition the equipment to allow full extension of outriggers.**
- (b) Do not move with a suspended load.
- (c) Do not conduct drag line movements.
- (d) Wear a seat belt in the crow's nest if operating a grapple truck **when so equipped.**

8122. When hoisting a load attach chains, cables, straps, slings, or tongs above the center of gravity of the load to prevent its tilting or falling over when lift is made.

8123. Use a tag line or non-conductive hand line of adequate length to assist in controlling a load being moved higher than knee level. See that others are in a safe position, then hoist slowly until the load line is vertical and the load is under complete control.

8124. When lifting a load with a crane follow this procedure:

- (a) The operator must know the weight of the load including rigging devices being lifted. Appendix A has common materials and weights.

- (b) Use an approved chain, sling, cable or other lifting accessory of the appropriate size, design, and capacity. Verify the identification patch or tag is legible. Be sure to not exceed the rating capacity of any rigging or crane.
 - (c) Be sure that the load is centered and the load is lifted at an even height with the sling or chain even and not twisted. If the load does not look secure or seem to be riding level, lower the load and take off all stress on the hoisting cables and sling before going back in to look at the cable securement.
 - (d) If it is not, make sure it is made at a point that will prevent the load from tipping when hoisting it.
 - (e) Be sure that the hitch is secure before giving the signal to hoist, or before hoisting.
- 8125.** Store ropes, cables, straps, belts, and other tackle where they will not contact the sharp edge of a material, tool, or corrosive material.
- 8126.** Before starting a hoisting operation, one qualified person shall be designated to give signals defined in Rule 8140. That person will be designated in the job briefing.
- 8127.** If an empty chain or cable sling is hanging from hoisting equipment the end of the sling must be placed into the ring attachment or the block hook before signaling to move the hoisting equipment.
- 8128.** Do not cause any uneven or fast movement in swinging the boom or in raising or lowering the load.
- 8129.** Never leave the controls of hoisting equipment temporarily unattended unless the load, bucket, magnet or other heavy attachment is left in a stable position on the ground or in a car.
- 8130.** The hoisting equipment operator must use a bell, siren, whistle, or horn to warn persons of an approaching load on hoisting equipment. A load must not be carried over others.
- 8131.** Stay clear of the boom, the swing of the cab, and the load, bucket or magnet being handled by hoisting equipment.
- 8132.** When two cranes or derricks are lifting the same load, one qualified person must be designated to direct the movements of both.
- 8133.** Do not ride or hang on tongs, sling, hook, down-haul weight, or load of hoisting equipment.
- 8134.** Never go between objects or obstructions and the load being handled.
- 8135.** Before you take hold of a cable, sheave, boom, or any potential pinch point, make sure that protection has been provided. When freeing a sling or hook, observe the arrangement of the load and be sure it has settled before unhooking it. Position yourself to prevent being caught by the sling, hook, or any part of the load. If you are working above ground level, position yourself to prevent falling and wear fall protection when required.











- 8136.** When necessary to guide a suspended load below knee level into position, push it instead of pulling. Be sure to keep your hands and feet from under the load. Maintain balance at all times.
- 8137.** Do not stop or suspend a load over a gas cutting welding outfit, or over any compressed gas cylinders.
- 8138.** When positioning and operating equipment, maintain a minimum clearance as follows based on voltage:

§1926.1408 TABLE A—MINIMUM CLEARANCE DISTANCES	
Voltage	Minimum clearance distance
(nominal, kV, alternating current)	(feet)
up to 50	10
over 50 to 200	15
over 200 to 350	20
over 350 to 500	25
over 500 to 750	35
over 750 to 1,000	45
over 1,000	(as established by the utility owner/operator or registered professional engineer who is a qualified person with respect to electrical power transmission and distribution).

Note: The value that follows "to" is up to and includes that value. For example, over 50 to 200 means up to and including 200kV.
 [75 FR 48142, August 9, 2010]

- 8139.** When operating boom truck mounted lifting equipment, if possible, do not operate the boom on the same side as the load that is being lifted.

8140. Use standard hand signals to govern movements of hoisting equipment.

 <p style="text-align: center;">Stop (A)</p> <p>Extend one arm and hold palm of hand vertical.</p>	 <p style="text-align: center;">Stop (B)</p> <p>Arm extended palm down, fist clenched, move hand right and left</p>	 <p style="text-align: center;">Hoist</p> <p>With forearm vertical, forefinger pointing up, move hand in small horizontal circles.</p>	 <p style="text-align: center;">Lower</p> <p>With arm extended downwards, forefinger pointing down, move arm in horizontal circles.</p>
 <p style="text-align: center;">Move Slowly</p> <p>Use one hand to give any motion signal and place other hand motionless in front of hand giving the motion signal.</p>	 <p style="text-align: center;">Raise Boom</p> <p>Arm extended, fingers closed, thumb pointing upwards.</p>	 <p style="text-align: center;">Lower Boom</p> <p>Arm extended, fingers closed, thumb pointing downwards.</p>	 <p style="text-align: center;">Hold Everything</p> <p>Clasp hands in front of body.</p>
 <p style="text-align: center;">Raise Boom Lower Load</p> <p>Right arm extended, thumb pointing upward, left arm extended downward swinging in horizontal circles.</p>	 <p style="text-align: center;">Lower Boom Raise Load</p> <p>Right arm extended, thumb pointing downward and left forearm and forefinger vertical, left hand in small horizontal circles.</p>	 <p style="text-align: center;">Slew (Swing)</p> <p>Arm extended, point with finger in direction of boom swing. (For overhead gantry crane move in direction indicated.)</p>	<p style="text-align: center;"><i>SAFETY MUST HAVE PRIORITY</i></p>



Use Auxiliary Hoist

Tap elbow with one hand, then use regular signals.



Travel Machine

(Point Direction)
(Crawler Cranes Only)
Arms bent at elbow, fists clenched, rotate both forearms around each other.



Travel One Track

(Crawler Cranes Only)
Lock the track on one side indicated by raised fist. Travel opposite track in direction indicated by circular motion of other fist rotated vertically in front of body.



Use Main Hoist

Tap fist on head, then use regular signals.



Extend Boom or Trolley Out

(Telescoping booms)
Both fists in front of body with thumbs pointing outwards.



Retract Boom or Trolley In

(Telescoping booms)
Both fists in front of body with thumbs pointing towards each other.



Finished With Crane

Place arms above head and cross hands.

HANDLING MATERIALS MANUALLY

- 8150.** When lifting or moving objects, follow these precautions:
- (a) Clear the path of obstructions and tripping hazards.
 - (b) Check for grease, oil, and sharp edges. Then grip the object firmly with the palms of your hands at the most suitable point.
 - (c) Tip the load to test the weight. Lift only within the limits of your physical capability. If necessary, get help or make additional trips.
 - (d) Have firm footing with one foot alongside the object and the other foot behind it, about shoulder width apart.
 - (e) Bend your knees and keep your back straight. Tuck in your chin to help keep your back straight.
 - (f) Keep your arms and elbows close to your body. Draw the object close and lift by slowly pushing up with your legs, avoiding sudden movements. Never twist your back to turn; turn your whole body.
 - (g) If you are losing your handhold or that a tool is losing its contact or grip, tell the person giving commands and gradually lower the object.
 - (h) If the object gets out of control, immediately move clear until it comes to rest.
- 8151.** When two or more people handle material, follow this procedure:
- (a) Perform a job safety briefing and review the briefing when conditions change.
 - (b) Designate one person to give all commands. Lift or move only on command.
 - (c) The person designated to give commands must fully inform those assisting what is to be done and what the words of command will be. The commands shall be in a loud and distinct manner.
 - (d) Long pipes, lumber, or other such items must be carried by two people, one near each end, under the following conditions:
 - 1) It is not certain that the object can be carried by one person without endangering others.
 - 2) The path of transport will go in or out of a doorway, or pass by it.
 - 3) The path of transport will round a corner.
 - 4) The object will be carried in a congested place.
- 8152.** Pile and stow material safely and in an orderly manner, interlocking it where practical. Avoid making high narrow piles. Remove material from the top instead of the side of a pile and avoid dislodging other pieces.
- 8153.** When loading or hauling material on trucks or trailers, take these precautions:
- (a) Inspect the equipment for any defects.
 - (b) Secure the material, if necessary.
 - (c) Block all round material.
 - (d) Place a red flag on the end of material extending beyond the rear of any equipment.
- 8154.** When moving hand trucks, trailers, or carts, face the direction of movement. Watch out for people and objects, and be prepared to stop. Be especially careful at corners, doors, and passageways.

- 8155.** When loading a cart or trailer, begin by loading the center, then load towards the sides or ends. When unloading a cart or trailer, remove the center portion of the load last.
- 8156.** Remove all protruding nails, staples, wires, loose bands or other such items from kegs, boxes or other containers and their covers as soon as they are opened. Fold and flatten any loose hoop or band and put it with the scrap.
- 8157.** Promptly remove nails, screws, hooks, or loose bands from lumber or other material to be reclaimed. On material that is not to be reclaimed, bend flat any such items sticking out from the material.
- 8158.** When handling metal track spike or track bolt containers use tongs when practical. Keep clear of metal projections and sharp edges when you handle or reach into the container. Only use approved steel pail openers for opening these kegs. Track spike and track bolt containers heavier than 50 pounds will not be handled manually. Appropriate mechanical lifting devices may be used to handle these containers.
- 8159.** Do not unload material from a train or self-propelled equipment unless the equipment is standing, or moving less than 5 MPH.
- 8160.** Follow these precautions when manually handling ties, timber or rail:
 - (a) Use good body mechanics and assume a stable braced position.
 - (b) Use proper tongs.
 - (c) Position the tongs as follows:
 - 1) Below the center line of the object.
 - 2) At the balance point along the length of the object (middle).
 - 3) At least 8 inches (20 cm) from the end of the object.
 - (d) Before lifting, make sure the tongs have a secure grip on the object.

PROTECTION AGAINST MOVING LOCOMOTIVES AND RAILCARS

- 8180.** When completing work on or about track, always have the proper roadway worker protection established.
- 8181.** Place equipment, material or objects at least 10 feet (3 m) from the nearest running rail.
- 8182.** Do not get on or off moving equipment except in cases of emergency.
- 8183.** Never get under or between equipment unless proper track protection is in place and equipment is properly secured against movement.
- 8184.** Never cross over moving equipment. If it is necessary to crossover standing equipment set up working limits. Conduct a job briefing with the train crew if a locomotive is attached. Request “3 Step” Protection. Once “3 Step” Protection is in place, you may crossover the equipment. Use only crossover platforms and hand rails. Do not hold any material in your hand which may interfere with three points of contact.

WORKING WITH FLAMMABLES, EXPLOSIVES, ACIDS AND VAPORS

- 8190.** Clean your hands, machinery, or equipment only with the approved cleaners.
- 8191.** Dispose of paper, rags, waste, or material saturated or coated with a flammable material in the manner designated by Genesee & Wyoming Standard Environmental Procedures.
- 8192.** Use only OSHA approved (or DOT approved where required by regulation) metal safety cans to store or transport gasoline, other flammables, or potentially explosive liquids. When inside buildings or storage facilities, store flammables and potentially explosive liquids in an approved flame-proof cabinet designed for that purpose. If flammable liquids are transported in a company vehicle, a Hazardous Materials Shipping document (HM 10 Form) must be filled out and kept in the vehicle until the material is removed from the vehicle. Do not transport these materials in the passenger compartment or trunk of a motor vehicle. Reference Genesee & Wyoming Standard Environmental Procedure GWE 231 for additional information.
- 8193.** To transfer gasoline or other flammables from a container or to fill fuel supply tanks, use the applicable precautions listed below:
- (a) Move the equipment outside the building if practical. Otherwise, open the windows before pouring and keep them open until the area is free of vapors.
 - (b) Turn the ignition off and be sure that the engine is stopped.
 - (c) Use a pump or safety can.
 - (d) Maintain metal contact between the nozzle, pipes, flexible hose or other attachment and the container to which you are transferring.
 - (e) If you cannot maintain metal contact with the container to which you are transferring liquids, you must ground the container.
 - (f) When filling a tank, leave a one-inch air space at the tip to prevent overflowing. Also, control the flow and handling to prevent spillage.
 - (g) Only fill portable gasoline containers on the ground.
 - (h) The use of a cell phone while fueling vehicles is prohibited.
- 8194.** Never use a source of heat to repair or dismantle any tank that has contained a flammable or combustible materials.
- 8195.** The use of or possession of torpedoes is prohibited.
- 8196.** When lighting and using fusees:
- (a) To light a fusee, hold the end to be lit downward and far enough away to prevent fire or sulfur dropping onto any part of your body or clothing. Expose the end of the cap and press it against the ignition powder. Pull the cap toward yourself and push the fusees away.
 - (b) When using the lit fusee, keep it at arm's length, below shoulder level. Move it slowly. Never place it on a wooden structure.

(c) To extinguish a fusee, tap the lit end over some low object until the lit end falls off. Make sure this end does not fall into weeds, grass, or other flammable material.

8197. Use fusees only as they are intended to be used. Store open boxes of fusees in an approved metal containers. Use only a proper metal container to transport them.

8198. Follow these precautions when storing compressed gas cylinders:

- (a) If a cylinder has a valve protecting cap, replace the cap as soon as the regulator is removed. Store cylinders with the valve protecting caps in place.
- (b) Store and secure cylinders in an upright position.
- (c) Keep oxygen cylinders at least 20 feet (6 m) from acetylene or propane cylinders, unless they are separated by a fire wall.

WORKING WITH ELECTRICAL APPARATUSES

8210. Work on or about electrical circuit, apparatus or equipment only if you are qualified and you know its operating voltage and service handled. Follow the lockout/tag-out procedure.

8211. Keep at least the distance defined below from a dangling wire or any object that may be in contact with an electrical current. Keep others away until qualified personnel are notified and take charge.

§1926.1408 TABLE A—MINIMUM CLEARANCE DISTANCES	
Voltage	Minimum clearance distance
(nominal, kV, alternating current)	(feet)
up to 50	10
over 50 to 200	15
over 200 to 350	20
over 350 to 500	25
over 500 to 750	35
over 750 to 1,000	45
over 1,000	(as established by the utility owner/operator or registered professional engineer who is a qualified person with respect to electrical power transmission and distribution).

Note: The value that follows "to" is up to and includes that value. For example, over 50 to 200 means up to and including 200kV.
 [75 FR 48142, August 9, 2010]

8212. If you are working in an electrical storm, apply proper grounds to aerial line wires, aerial cables, and associated apparatus before you work on them.

8213. Use any device, appliance or tool only if it is designed for use in the maintenance and operation of an electrical circuit. Wire, wet rope, steel tape line or linen tape line containing metallic reinforcement must not be used around energized wire, apparatus or equipment. Never use a metal ladder.

8214. Do not depend upon insulation, weather proofing or covering on wire, electrical apparatus or equipment for protection against shock.

8215. Wear electrical protective gloves that are in date and inspected to remove or replace fuses on an energized circuit of 175 or more volts. Use a fuse puller or hot stick. Unless you are protected by sleeves and blankets, observe the safe distances listed below for work near electrical circuits, apparatus or equipment energized at the shown voltages. These distances apply to your body, tools, and material being handled.

300 volt and less	- Avoid contact
300 to 600 volts	- 2 foot (.6 m)
601 to 2,500 volts	- 4 feet (1.2 m)
2,501 to 9,000 volts	- 5 feet (1.5 m)
9,001 to 25,000 volts	- 6 feet (1.8 m)
25,001 to 75,000 volts	- 8 feet (2.4 m)
Over 75,000 volts	- 10 feet (3 m)

8216. Before making a dielectric or load test, take the following precautions:

- (a) See that the test ground lead is solidly grounded.
- (b) Surround the unit, locomotive or other equipment with rope or tape that is at least 3 feet (.9 m) from the equipment, and place caution signs properly. OR Make the test in an area that is marked with yellow painted lines and marked with permanent warning signs.
- (c) See that others not engaged in making the test are in the clear.
- (d) Alert others in the vicinity of the roped off test area or a permanently marked area that a test is in progress.
- (e) Wear hearing protection when noise levels are above 85 decibels or where posted.

8217. Follow these precautions before working on electrical apparatus:

- (a) Before you work on a transformer, remove the primary fuses and open the secondary circuit.
- (b) Before you work on electrical operated equipment or apparatus, open the control cut-out switch.
- (c) Before you work on signal power equipment or apparatus open all necessary circuit breakers. Block relays. Open control cutout switches to prevent automatic starting of signal generator set or operation of circuit breakers.
- (d) Before you work on a broken conductor normally energized at 600 or more volts, place grounding devices on both sides of the break.
- (e) Before you work on a static condenser or capacitor, make sure it is discharged.

8218. Wear electrical protective gloves when closing an energized circuit breaker by hand. Close contacts as quickly as possible.

8219. Before you open or close the disconnect switch in line with the circuit breaker, make sure the contact breaker has been opened. Only if the circuit breaker is a non-trip type may you leave it closed when closing the disconnecting switch.

- 8220.** When operating a circuit breaker follow these precautions:
- (a) Open the circuit breaker before you open or close the disconnect switch in line with the circuit breaker.
 - (b) When you are closing an energized circuit breaker by hand, wear electrical protective gloves and close the contacts as quickly as possible.
 - (c) Do not operate a circuit breaker by hand if the circuit breaker is not equipped with a platform and the lever will travel beyond your reach.
- 8221.** To apply or remove a grounding device, follow the procedure below:
- (a) Keep as far as practical from circuit. If possible, keep below it and to the side from which the wind is blowing to be clear of any resulting arc.
 - (b) Secure the device to the ground connection before placing the other end in contact with the line, apparatus or equipment.
 - (c) When removing the grounding devices, disconnect them from the line, apparatus, or equipment before removing them from the ground connection.
- 8222.** Define the limits of clearance protection for safely working on any electrical apparatus with barricade, tape, or rope.
- 8223.** When removing and replacing a fuse follow these precautions when working on an energized circuit of 175 volts or more:
- (a) Wear electrical protective gloves.
 - (b) Use a fuse puller or hot stick.
 - (c) Make sure that the replacement fuse is rated for the correct voltage, continuous current, and interrupting current.
- 8224.** When you are working near a control board that is equipped with an electro-static ground detector and that is energized with high voltage take these precautions:
- (a) Always keep your body at a safe distance.
 - (b) Make sure that all tools and other materials you are using do not come in contact with the control board.
- 8225.** When necessary to work on electrical, hydraulic or other circuit supplying energy to equipment or other device, observe the following lock-out / tag-out procedures:
- (a) Notify the device operator that the power circuit is to be de-energized.
 - (b) De-energize the circuit, securely attach a warning tag to each switch, and lock each switch with a private lock as it is opened.
 - (c) The warning tag may be removed or the switch may be operated only by the employee who applied the tag. If the same employee is not available to work on that particular circuit, their supervisor may arrange for the removal of the warning tag for the purpose of putting other employees on the job. These employees shall place their warning tags as outlined.
 - (d) If necessary to keep the circuit de-energized for a period of time longer than the hours of duty of the person who applied the original warning tag, the person who relieves them shall apply their own warning tag as soon as the original tag is removed.

- (e) If the person who applied the warning tag is not relieved by another employee, the warning tag shall remain on the switch until their next tour of duty.
 - (f) When work on the circuit is completed, both workmen and operator shall satisfy themselves that the machinery is in proper shape for operation. Warning tags shall then be removed and switches and circuits re-energized.
- 8226.** To extinguish a fire near an energized electrical circuit, equipment or apparatus, follow this procedure.
- (a) Keep in the clear until you are sure that circuits have been de-energized and grounded.
 - (b) Proceed only when authority has been granted to do so.
 - (c) Use sand, other extinguishing means, or an approved extinguisher for such purpose. Use the extinguisher according to applicable instructions.
 - (d) Never direct water hose stream close to energized circuits, equipment, or apparatus.
 - (e) Keep clear of an area in which wire, cable, equipment, apparatus, or other items are likely to fall.
 - (f) In using chemical or other fume-producing firefighting means, attempt to have ample fresh air circulation. Keep clear of a confined place.
- 8227.** Enter a substation to a power plant only when you are authorized and performing your duty.
- 8228.** To avoid electric shock from arcing, do not stand with your hands behind your back when your back is toward a generator or switchboard.
- 8229.** Do not use anything in place of an electrical fuse.
- 8230.** When operating an open-type switch or circuit breaker, keep your face turned away from it, and stand at arm's length. Eye protection required.
- 8231.** When stringing or removing wire or messenger near a high voltage circuit de-energize and ground the circuit. Apply grounds to the wire or messenger.
- 8232.** Keep all doors and covers of electrical apparatus in place and secured except when necessary to open them for inspection or repair. If doors are missing, shut down the electricity to the box or apparatus and tag it out of service until the doors are replaced.
- 8233.** When you are not using extension electric cords, hang them up. Arrange them so they will not be a tripping hazard.
- 8234.** Never enter into or work in any locomotive or confined area where electrical apparatus is energized while carrying metal objects or electricity-conductive tools, or other objects on your person such as in your pockets that may come in contact with electrical circuits resulting in possible electrocution.

PERFORMING SPECIFIC TASKS

GAS CUTTING AND WELDING

- 8300.** Weld or cut only if you are qualified. Inspect all hoses and couplings before you use them. Replace the defective item immediately. When you are cutting or welding, keep your hose in a safe position at all times. Position it so that sparks or molten metal cannot fall on it, and so that equipment and vehicles will not run over it.
- 8301.** Pressurized cylinders must be secured by a cradle or on a platform designed for hoisting before you lift them with hoisting equipment. You must apply the protective cap before any lifting. Only lift cylinders with a cylinder tote.
- 8302.** Propane or acetylene gas torches must be equipped with check valves.
- 8303.** Propane or acetylene regulators must be equipped with flash arrestors.
- 8304.** Use only an approved flint lighter to ignite acetylene or propane. Keep a lighted torch in your hands at all times.
- 8305.** Before making a cut with a torch, be certain that there is no person on the other side. Make sure that there are no other conditions that could prove dangerous to the operators or others.
- 8306.** Before you cut, weld, or heat a container, cored casting, pipe, plugged holes, or other such object, make sure that it is properly vented or drilled so that gas, steam, or hot air will escape.
- 8307.** Before you operate a torch on or near a receptacle, make sure that no gas will be generated by oil, grease, or other combustibles. Make sure the receptacle is well contacted. Make sure that fumes from the torch will not accumulate.
- 8308.** When lighting a torch follow these precautions:
 - (a) Purge the oxygen and acetylene/propane lines for a few seconds before you light the torch.
 - (b) Do not attempt to stop the flow of oxygen or acetylene/propane by crimping the hose.
- 8309.** Close the torch valve before laying it down, climbing, or passing it to another person. Never leave a lit torch unattended.
- 8310.** Do not use a torch to light a fire, other torch, cigarette, or any other item.
- 8311.** Regulators and gauges must be professionally inspected and certified every 12 months. Mark the date of inspection on a small tag posted on the inside of the regulator lens face.

- 8312.** Upon completing an operation or before moving portable welding or cutting outfits, take the following action:
- (a) Close cylinder valves.
 - (b) Open torch valves alternately to relieve pressure on gauges.
 - (c) Release regulator valve screws and close torch valves.
 - (d) If equipped with DOT (or equivalent regulatory authority for non-US operations) highway transport approved safety caps, close cap and secure with the supplied locking device. It is prohibited to operate highway vehicles on public highways with regulators attached to the cylinders unless the cylinders are equipped with safety caps that are approved for highway transport. If these caps are not applied to the cylinders, the outfits must be broken down and properly stored with safety caps applied.
- 8313.** Keep oil, grease or any fuel supply away from cylinders or associated equipment. Do not handle the valve on an oxygen cylinder with oily hands or gloves.
- 8314.** Be careful when handling coiled welding wire.
- 8315.** Do not leave electrodes in welding tongs when you are not actively welding.
- 8316.** Never use compressed gases to cool yourself or others. Never use compressed gases to blow off or clean off your skin or clothing.
- 8317.** Never burn, cut, heat or weld when a butane, “ZIPPO” or other type of cigarette lighter is in your pocket or clothing. A defective, leaking or overfilled lighter may ignite from sparks causing an explosion.

THERMITE WELDING

- 8330.** When Thermite Welding follow these precautions:
- (a) Before you place the contents of charge into the crucible, make sure that molds, crucibles, and other items are dry and free of grease or oil.
 - (b) Place the entire contents of charge into the crucible.
 - (c) Before you ignite the powder, place the cap on the crucible and position yourself to avoid injury from gases or molten metal that may be discharged from the crucible mold.
 - (d) Stand upwind of and at least 10 feet (3 m) from the crucible during the reaction. *Exception: This precaution does not apply if you are rail bonding.*
 - (e) Do not try to stop a leak. Stay away from the crucible.
 - (f) Before you open the cover, allow enough time for the metal to solidify after the weld is made.
 - (g) Do not dispose of hot slag from the pan in snow, puddle or other wet area.

CUTTING A TREE

- 8331.** When cutting or trimming a tree follow these precautions:
- (a) **Employees must be trained (by professional tree cutting instructors) and qualified in the cutting of trees (classroom and field). The training must be repeated at least once every three years.**
 - (b) **Use of a grapple truck, backhoe, or boom truck is the safest way to remove a tree from the right of way. The number of saw cuts shall be minimized and the lifting device used when available.**
 - (c) **Refer to Chain Saw Use Decision Matrix in appendix B to determine if the use of a chain saw is allowed with the situation at hand.**
 - (d) Look for wires running through or near the tree. Trim limbs so that they will not fall on wires.
 - (e) **Beware that cutting will change the internal potential forces within the tree.**
 - (f) When working in a tree, use a hand saw, trimmer, or other suitable tool instead of an axe or hatchet.
 - (g) Ensure that the tree or limb will fall in the desired location by cutting a notch on the side being cut and using suitable wedges in the cut. Pull the tree with a rope or other suitable means if necessary.
 - (h) Make sure that all persons, including yourself, are clear of the falling tree or limb.
 - (i) **Only one person at a time may cut a tree.**

HEATING A RAIL WITH FUEL SOAKED MATERIAL

- 8332.** When heating a rail with a material soaked in fuel oil, follow these precautions:
- (a) Keep the rope in a container with handles and a secure lid.
 - (b) Use this container to carry the rope to the work location.
 - (c) Using hand tools, such as a lining bar or ballast fork, remove the soaked coil of rope from the container and place it in position at the rail.
 - (d) Make every effort to avoid touching the fuel soaked material with your hands. If you must touch the rope with your hands, use rubber gloves. Be extremely careful that the soaked rope does not contact your clothing.
 - (e) Ignite the rope from the upwind side.

EXCAVATIONS

- 8333.** Identify underground utilities before you excavate. Call the utility company and appropriate local departments to mark underground utilities. Avoid hitting underground utilities, cables and pipelines when you excavate.
- 8334.** Properly protect all pits, excavations, manholes, turntables, and inspection pits where a fellow employee or other person is likely to walk. Assign an employee to warn people approaching the opening, or place suitable guards around the

opening, such as railings, barricades, high visibility barrier tape or stakes. If an excavation is near a track or at a place where a person may walk, protect the excavation and mark it with lights if necessary.

- 8335.** Do not work in an excavation where equipment is operating unless you are required to do so to perform your duties, and you can keep at least 50 feet (15.2 m) away from the rear and 25 feet (7.6 m) from the side of equipment operating.
- 8336.** Do not work in a trench more than 4 feet (1.2 m) **deep or a different depth as required by local, state, or provincial requirements unless:**
- (a) An entrance or exit is within 25 feet (7.6 m) of your work area.
 - (b) The excavation is properly sloped and/or shored in accordance with a plan approved by the Regional V.P. – Engineering.
- 8337.** Store excavated material and other material at least two feet from trench edges.
- 8338.** Keep a safe distance from the edge of a pit or trench, unless constructing, inspecting, maintaining or using it. Keep equipment far enough from the edge of an excavation to avoid imposing strain from vibration on the trench walls.

LADDER, SCAFFOLD, TRESTLE, AND WORKING AT AN ELEVATED PLACE

- 8350.** Do not climb or work at places of height unless trained and qualified in the use of personal fall protection equipment in accordance with the Bridge Worker Safety and Fall Protection Rules. Places of height to be avoided are:
- (a) Working on or about a railroad bridge unless working exclusively within the gage of the track unless the bridge is equipped with effective walkways and handrails. Working between the gage means no load bearing or force is exerted outside of the rail.
 - (b) Working beyond the plane of the handrail protecting an edge or opening.
 - (c) Working on mobile platforms.
 - (d) Working in a shop or fixed facility within 6 feet (1.8 m) of an unprotected edge or wall opening more than 4 feet (1.2 m) off the ground.
 - (e) In addition, regulations in Canada stipulate working in the field within 6 feet (1.8 m) of an unprotected edge more than 7 feet 10 inches (2.4 m) off the ground.
 - (f) In addition, regulations in the United States stipulate:
 - 1) Ascending an uncaged, fixed ladder more than 24 feet (7.3 m).
 - 2) Where the top of the ladder is more than 24 feet (7.3 m) in height it must be equipped with a cage or fall protection must be used.
- 8351.** Do not climb or work over water 4 feet (1.2 m) and greater in depth or where the possibility of drowning exists unless trained and qualified in the use of personal fall protection equipment in accordance with the Bridge Worker Safety and Fall Protection Rules.
- 8352.** When necessary to reach an elevated place, use only an approved ladder, scaffold or man lift. While fall protection is not specifically required when using a step

ladder, consider the location, duration and nature of the task before engaging ladder work without being trained in the use of fall protection.

8353. When using ladders:

- (a) Follow manufactures recommendations with respect to setup and use of ladder.
- (b) Use commercial ladders specifically approved for the work at hand. i.e. fiberglass ladders equipped with pole brackets when working around electrical poles and equipment.
- (c) Inspect ladders prior to use. Closely inspection of the ropes, hooks, fasteners, braces, and other moving parts. Ladders with any damaged components shall be removed from service and replaced.
- (d) Use only on firm ground.
- (e) Do not over extend your reach. Do not reach out more than one arm's length from the side of a ladder.
- (f) Use a 4:1 vertical to horizontal ratio when using a straight ladder.
- (g) Ensure the ladder extends at least 3 feet (.9 m) above the next higher working surface.
- (h) Do not place ladder near a door that can swing open without properly protecting against the door moving.
- (i) Face the ladder and maintain three points of contact at all times
- (j) Do not carry objects when ascending or descending.
- (k) Do not climb a ladder that is occupied by another person.

8354. Scaffolding used for any work shall be commercial systems specifically designed and erected for use as scaffolding. Prior to use, the employees using the scaffold system must be trained in its proper erection, inspection and use.

8355. Keep from under overhead work, unless the nature of your work requires it. If you must pass under overhead work, job brief with the workmen above to ensure they take precautions to prevent falling objects as you pass under the work.

8356. When necessary to work, walk, or stand above employees already engaged in work on a lower level, job brief with the workmen below so they understand the nature of your work and the precautions to prevent falling objects. Barricade or rope off a sufficient area on the lower level to ensure personnel and equipment are not impacted by the work above.

8357. If the nature of the work creates a floor opening, wall opening, or other excavation, the edge must be protected with a visual or physical barrier. Visual barriers shall be placed a minimum of 6 feet (1.8 m) from the unprotected edge. Where there is insufficient room for the 6 foot (1.8 m) warning barrier then an effective hand rail with a top rail not less than 42 inches (1.0 m) (high, a mid-rail and a toe-board must be erected to protect the edge. Such handrails shall be of a design approved by Regional V.P. – Engineering or their designee. If necessary, illuminate the protection and/or station an employee to protect others.

- 8358.** Do not throw items to or drop items from an elevated place. Use a hand line or proper hoist.
- 8359.** Do not jump from a platform, or other elevated location. If necessary to descend without a ladder or steps:
- (a) Observe the ground or floor condition and avoid holes, slippery spots or obstructions; then,
 - (b) Assume a sitting position with your legs hanging over the edge to decrease the distance to the ground while maintaining a handhold on a suitable object, if available; and,
 - (c) Slowly descend in a manner that both feet contact the ground at the same time.

WORKING AT GRADE CROSSINGS

- 8380.** Follow these precautions when repairing cantilever signals or crossing gates:
- (a) Avoid standing or working in a traffic lane.
 - (b) Before you work on rotating gate pedestals or cantilever arms, swing them out of the traffic lane.
 - (c) Before you work on non-rotating gate pedestals or cantilever arms, flash all warning lights before you occupy the traffic lane.
- 8381.** When working within 15 feet (4.5 m) of a highway crossing, use additional protective devices such as flares, reflective triangles, or a vehicle's four-way emergency flashers or strobe lights.

WORKING AROUND TRACKS AND EQUIPMENT

GENERAL RESPONSIBILITIES

- 8400.** Expect equipment to move on any track, in any direction, at any time. Do not get closer than 50 feet (15.2 m) from standing equipment without proper on-track safety and knowledge that equipment is secure. Look in both directions before making any of the following movements:
- (a) Fouling or crossing track.
 - (b) Crossing between or around the end of equipment.
 - (c) Moving from under or between equipment.
 - (d) Getting on or off standing equipment.
 - (e) Operating a switch.
 - (f) Crossing tracks. When doing so take the shortest and safest route. If more than one track is to be crossed stop and look in both directions before crossing each track. Do not cross more than one track unless you have nothing impeding your ability to walk across all the tracks to reach the place of safety. Do not cross in front of a moving train or equipment unless it is a sufficient distance away to permit reaching the opposite side in a safe manner.

- 8401.** Employees are prohibited from operating or riding on locomotives, cars, motor or hand push trucks or any type of equipment, except as necessary in the discharge of their duties and with proper authority.
- 8402.** Place your feet firmly and have secure handholds when engaged in any of the following:
- (a) Coupling or uncoupling an air hose or steam connector.
 - (b) In any other operation or situation on the ground, equipment, or at an elevated location or elsewhere when necessary to maintain stability.
- 8403.** When getting on or off equipment, take the following precautions:
- (a) Look for obstructions, openings, or any other such hazard and avoid them.
 - (b) Use only the handhold, ladder, step, stirrup or other part designed and placed for the purpose. Maintain secure handholds and place your feet firmly.
 - (c) Face the equipment, unless you are on a passenger car. This exception applies only when you are at a platform location.
 - (d) Keep your body as close as possible to the equipment.
 - (e) Use the side of equipment away from the main or live track if practicable.
 - (f) Always maintain three points of contact when mounting or dismounting equipment.
 - (g) Place the heel of your shoe against the outside edge of the rung or stirrup, if possible. Otherwise, use the ball of your foot turned slightly sideways.
 - (h) Use available walks and keep your feet clear of knuckle, the cutting lever, and the space between the coupler shank and the end of the car.
- 8404.** Follow these precautions when riding on roadway maintenance machines or hi-rails:
- (a) Do not ride on maintenance-of-way equipment unless a safe and secure position with handholds, handrails, or a secure seat or bench position for each roadway worker transported on the machine and mark with a sign or stencil.
 - (b) Wear a seat belt, if one is available (seat belts are not required in hi-rail vehicle when on the rail).
 - (c) Face the direction of the movement if possible.
 - (e) Keep a handhold on a suitable object.
 - (f) Ride the caboose platform only if you are required to do so.
 - (g) Move about only as needed to perform your duties.

- 8405.** When riding locomotive or rail cars, do not ride, stand or sit on the following:
- (a) Step.
 - (b) End sill.
 - (c) Coupler.
 - (d) Between units, cars or equipment.
 - (e) Top of, side, or end of open top car.
 - (f) Edge of flat car.
 - (g) Any part of the equipment where your foot, hand, or any part of your body would project beyond the side of the equipment.
- 8406.** Do not place clothing, tools or other objects where they will foul ladder rungs, running boards, steps, end sills, or safety appliances.

ON OR NEAR WORK TRAINS

- 8407.** Ensure that train coordination or working limits is established with the train crew as the method of on-track safety on controlled tracks before beginning any work train activity. On non-controlled tracks, working limits must be established with the work train moving only as directed by the EIC. When operating or working on a dump car, keep all parts of your body clear of moving equipment parts.
- 8408.** Always wear the proper personal protective equipment including a respirator as defined by the Respirator Selection Guide when unloading ballast. When unloading ballast, stop the train when you are:
- (a) Inserting a tie under a car.
 - (b) Removing a tie from under a car.
 - (c) Attaching a come-along to a car.
 - (d) Attaching a chain to hopper doors.
- 8409.** Follow these precautions before you signal a train or locomotive crew to move a train:
- (a) Warn all persons on the ground of the movement.
 - (b) Warn employees in or about the equipment of the movement
 - (c) Make sure that all persons on the ground are clear.
- 8410.** When opening or closing a hopper car drop bottom door, use the following procedure:
- (a) Obtain “3 Step” Protection from the conductor before you foul the track.
 - (b) Make sure that all persons are clear of the door on the opposite side of the car.
- 8411.** When closing a drop bottom door use the following procedure:
- (a) Keep your hands and fingers clear of the jamb or door frame.
 - (b) Make sure that any workmen on the other side of the car are clear of the door.
 - (c) To keep from losing your balance, grasp the flange or angle on the side of the car.
 - (d) Place your foot on the push or locking casting of the door where it is corrugated for this purpose.
 - (e) Swing the door with your foot until the door is engaged in the first notch of

the lock.

- (f) Use the bar in the socket provided to engage the door latch in the second notch, or closed position.

8412. To secure a latch bar, securely place a suitable bar in the loop provided and pull steadily on the bar until the latch bar securely engages the hook.

8413. Do not operate a plug type side door of a box car.

8414. To open a knuckle on standing equipment, use the following procedure:

- (a) Stand clear at the side of the equipment.
- (b) Check for a knuckle pin in the knuckle. If the pin is missing, be extra alert in your procedure: when the knuckle falls to the ground it may bounce.
- (c) In a braced position, face the end of the equipment.
- (d) Grip the extreme end of the cutting lever handle, at arm's length.
- (e) Slowly lift the cutting lever handle a short distance until the anti-creep slack is taken up (you will hear a click).
- (f) Quickly and without a jerk, continue lifting the cutting lever handle and carefully pull the knuckle open.

8415. To operate a cutting lever on standing equipment, take the following precautions:

- (a) Exert only the amount of pressure that will permit maintaining a secure handhold and firm footing.
- (b) When on the ground, use only one hand, maintaining a secure handhold with the other, if possible.
- (c) Operating a cutting lever on moving equipment is prohibited.

8416. Do not use your finger to adjust the lock pin or lift assembly at the bottom of a coupler. Use the proper tools for the task.

ROADWAY MAINTENANCE MACHINES AND HI-RAIL EQUIPMENT

8417. Operator must:

- (a) Ensure proper track protection is in place before operating on track.
- (b) Use equipment only to its rated capacity.
- (c) Inspect the equipment before use for a properly maintained back up alarm, top mounted flashing amber light, 5BC fire extinguisher or larger, first aid kit, and flagging equipment.
- (d) Display headlights, taillights, and strobe lights when on track (**unless parked at work site for an extended time**) or otherwise required,
- (e) Conduct a roll by inspection when there is more than one occupant. If the operator is alone, the operator should verify all wheels are in the proper position and spinning.
- (f) Conduct a brake test within the first quarter mile of travel to verify braking ability.
- (g) Beware of weather conditions that may increase stopping distance required.
- (h) Never leave running mechanized equipment unattended.

- (i) See that lockout/tag-out devices are in place before maintaining equipment.
 - (j) Properly maintain equipment in their charge.
- 8418.** If full attention cannot be devoted to controlling the movement of on-track equipment, the equipment must be stopped.
- 8419.** When main track or siding switches are to be thrown for inspection or other purposes, on track equipment must stop short of the turnout. After the work is complete, the switch must be lined and locked in the normal position and then the turnout must be operated through by the on track equipment. If there is more than one person present, after the switch is returned to the normal position and locked, the person handling the switch must state “MAIN LINE LINED AND LOCKED” to the other person who will verify the position of the switch and repeat the statement.
- 8420.** When working on or around self-propelled roadway maintenance machines, follow these precautions:
- (a) All persons operating and riding on self-propelled equipment must understand the duties that each person will perform.
 - (b) Use the handrail when getting on, riding on, and getting off equipment.
 - (c) Do not get on or off moving equipment.
- 8421.** Follow these precautions when riding on roadway maintenance machines:
- (a) Do not ride on material, tools, or other items loaded on a car, vehicle, trailer, or equipment.
 - (b) Do not ride on equipment, including rolling stock, vehicles, or trailers, with your feet hanging over the side or end, unless you must do so to perform your duties.
 - (c) Do not sit on equipment and propel it with your foot.
 - (d) If you have been authorized to stand while riding on equipment, be prepared for sudden stops.
- 8422.** When two or more employees are on self-propelled equipment, one must be positioned to have the best possible view to the rear. That employee must watch for overtaking equipment or trains and must watch over any equipment being towed.
- 8423.** Follow these precautions when operating self-propelled roadway maintenance machines:
- (a) Make sure that all riders understand the duties that each employee will perform.
 - (b) Assign a seat location to each rider.
 - (c) When equipped seatbelts are to be worn when riding in or operating equipment (except hi-rail vehicles).
 - (d) When employees are getting on, getting off, or between self-propelled equipment, disengage the clutch or gears and set brakes to hold.
 - (e) Secure movable working parts in the “UP” or “CLEAR” position before moving.

- (f) Inspect the equipment prior to use and document the inspection on the proper form. Test the brakes immediately before starting the trip.
- (g) Do not allow anyone to distract you or to interfere with your duties. If this happens, stop all movement.
- (h) Constantly look out for obstructions or unsafe conditions in the direction you are moving. If you cannot see ahead, designate another employee to keep a lookout.
- (i) If a person or animal is near equipment:
 1. Reduce speed.
 2. Sound the horn.
 3. Be prepared to stop.
- (j) When you are descending a steep grade, keep the clutch engaged and use low or second gear to control the speed of the equipment.
- (k) Keep a minimum of 200 feet (61 m) when traveling and 50 feet (15.2 m) when working between equipment to avoid collisions. Increase the distance between equipment when the rail is wet or the equipment is moving on territory with grades or curves that limit sight distance. **When a rail flaw detector car or geometry measurement car is involved with the on-track work group, keep a minimum of 500 feet (152m) when testing/traveling and 200 feet (61m) when stopped to avoid collisions.**

8424. Follow these precautions when parking on-track, self-propelled roadway maintenance machines:

- (a) Stop the engine or motor and remove the ignition key.
- (b) Engage the clutch or gears and set the brakes to hold.
- (c) Unless protected by a derail to prevent movement of the equipment from fouling other tracks, chain one wheel to the rail and lock it with a private lock. If several pieces of equipment are coupled together, chain the wheel of a piece of equipment at the end of the track. If the wheel is solid, run the chain around the head end of the frame or other sturdy part of the equipment.
- (d) Lock and spike the switch that controls entry to the track. If the track may be used for other purposes, apply and properly secure a derail and a red sign at least 150 feet from the equipment. If a derail is applied, immediately advise the transportation department.

8425. Follow these precautions when moving equipment on the track:

- (a) Push equipment from the rear, when possible. Keep clear of the front end of the equipment.
- (b) If equipment must be pushed from the side, keep your feet as far as possible from the wheels.
- (c) Place your hands where they will not be caught by moving parts or by rolling, shifting, or falling objects.

- 8426.** When coupling equipment, use only an approved rigid tow bar equipped with safety chains. Do not leave one end of a tow bar coupled if the other end has been uncoupled.
- 8427.** If equipment is not continuously attended, follow these precautions to protect the equipment from moving:
- (a) Stop the engine or motor and remove the ignition key.
 - (b) Engage the clutch or gears.
 - (c) Set the brakes to hold, if the equipment is so designed.
 - (d) For each end piece of equipment, run a chain through one wheel and around a rail. If the wheel is solid, run the chain around the head end of the frame or other part that will not allow the chain to slip off. At the end of a tour of duty, lock the chain with a private lock.
- 8428.** On-track equipment must move prepared to stop within one half the range of vision. It must not exceed the speed authorized for trains on the same track (exceptions to this must be approved by the Regional V.P. – Engineering and then only to allow up to 25 MPH speeds). It must not exceed the maximum speeds indicated in the following table. Operating speeds are always limited to the manufacturer’s specifications. Allowances must be made for weather conditions (dew, rain, fog, frost, snow, etc.) and other circumstances (leaves, grease, etc.) that may increase the braking distance or reduce the sight distance of on-track equipment.

Maximum Authorized Speeds

Operating a hi-rail passenger vehicle (10,000# GVWR or less)	Forward – 40 MPH Backward – 20 MPH
Operating a hi-rail truck (10,001# GVWR or more)	Forward – 30 MPH Backward – 10 MPH
Operating any other track car	Forward – 30 MPH Backward – 10 MPH
Approaching a work station on the track where you are running, or on an adjacent track.	Be prepared to stop short until you can see that the employees are clear.
When a train or locomotive is standing on the adjacent track.	10 MPH
When a train or locomotive on the adjacent track passes a hi-rail vehicle or other track car.	Stop.
Running over a railroad crossing at grade, switch, turnout, derail, or through open side of frog.	5 MPH
Running in any condition or obstruction that prevents the rail wheels from moving freely.	5 MPH
Operating rail detector or geometry cars	Manufacturer's specs.

8429. Follow these precautions when passing a highway grade crossing:

- (a) Stop at all public crossings at grade. Only proceed when the way is clear.
- (b) Approach farm/private crossings prepared to stop and stop short of the crossing at grade if there is any equipment or vehicles approaching. Only proceed when the way is clear. Private crossings with a high level of vehicle traffic must be treated as a public crossing at grade.
- (c) Before you proceed over the crossing, make sure there is time to do so safely.
- (d) Do not rely on active warning devices to warn approaching motorists. If a DTMF system is used to activate the warning devices the on-track equipment may proceed over the crossing once the way is known to be clear of highway traffic.
- (e) If a vehicle is approaching, stop your equipment and allow the vehicle to pass over the track. Signal the driver to proceed, if necessary.
- (f) If your view of the highway traffic is restricted in any way, stop your equipment clear of the crossing and provide flagging protection.

OTHER EQUIPMENT

- 8430.** Follow these precautions when hauling material or tools on push trucks:
- (a) If material or tools are stacked high enough to fall, use side stakes or racks.
 - (b) Distribute the load evenly, as follows:
 - 1) Lay tools flat with their points to the rear.
 - 2) Lay heavy items toward the trailing end.
 - (c) Make sure that items are clear of operating controls, moving parts, seating space, standing space, and handrails.
 - (d) Only use two bars with safety chains.
 - (e) Haul long material using two or more push trucks, if possible.
- 8431.** Follow these precautions before operating a jet or rotary snow blower:
- (a) Clean steps and platform.
 - (b) Inspect the lights, test the horn, and inspect the brakes.
 - (c) Notify the employee in charge of the track you will be clearing. Make sure the employee in charge is aware that you will be operating the snow blower and is aware of the potential hazards, such as flying debris.
 - (d) Raise and center the nozzle.
- 8432.** Follow these precautions when operating a brush cutter:
- (a) Constantly look out for people or animals that may be struck by the cutter or by flying debris.
 - (b) To avoid picking up debris, keep the cutting head at least 12 inches (30 cm) above the ground line.
 - (c) Stop work within 300 feet (91 m) of people or animals that may be struck by the cutter or by flying debris. Do not resume work until they are clear.
 - (d) Stop work within 300 feet (91 m) of a public thoroughfare unless traffic is being flagged.
 - (e) Stop work within 300 feet (91 m) of buildings without the use of specialized cutting heads that restrict material from being thrown from the cutter.
 - (f) Before you leave the controls, stop the engine or motor and wait until the cutting head stops rotating.
- 8433.** Follow these precautions when operating a Hi-rail Rotary Dump Truck:
- (a) Use the equipped tongs to tie the truck to the rail before dumping. If on Head-Free rail, use chains to tie down the truck to add extra protection.
 - (b) Exercise caution when unloading material while moving.
 - (c) Exercise caution when unloading material on the low side of curves.
- 8434.** Follow these precautions when operating a backhoe or tractor:
- (a) Do not back up when hi-railing unless hi-rail wheels are installed on the rear wheels.
 - (b) Remove your hands and feet from the controls of a backhoe if it is required for another person to enter the red-zone except when the backhoe is needed for the task to be performed. If the person is going to be in the red-zone for an extended period of time, lower the boom and turn off the equipment.

- (c) Beware of the higher center of gravity. Keep the load as low to the ground as possible. Keep the bucket uphill when traversing or navigating slopes. Keep the bucket around 16 inches (40 cm) off the ground.

8435. Follow these precautions when operating or riding on a snowmobile:

- (a) Wear goggles and a helmet designed to be worn on a snowmobile.
- (b) Before you foul track, have proper protection as per the rules.
- (c) Before you start a snowmobile, test the brakes and throttle and make sure that they are not stuck or frozen.
- (d) Turn on the headlight and taillight while the snowmobile is in operation.
- (e) Be alert for wire, cable, gut wires, and other obstacles.
- (f) Do not travel over frozen bodies of water.
- (g) Stay seated at all times. If you are a passenger, keep a firm grip.
- (h) Periodically test braking distances at various speeds and surface conditions. Do not drive at a speed that the brakes will not allow you to stop in time.
- (i) Give traffic the right of way at intersections and road crossings.
- (j) Make sure that snowmobiles travel in pairs when making long trips or during severe weather conditions.

8440. Follow these precautions when operating a fork lift truck:

- (a) Test the brakes, lights, horn, steering, and backup warning device before operating the forklift. Wear seat belts at all times. Do not operate if these items are not working.
- (b) Space the forks so as to completely support the objects being handled. Secure the load to the forks, if necessary.
- (c) Observe the ground or floor conditions and regulate the height of the forks so as to maintain a distance of at least 6 inches (15 cm) between the fork and the ground or floor.
- (d) If you must leave the forklift unattended, place the forks on the ground or floor, shut off the motor and apply the handbrake.
- (e) Sound horn at corners, doors and passageways.
- (f) Employees are not permitted to stand on or ride on the forks of a forklift for any reason.
- (g) If such operation is required, do so only through the use of an approved, safe and sturdy platform with hand railings designed for that purpose. Such platform can then be safely raised and lowered by use of a forklift.
- (h) Always keep hands, feet, clothing, tools or other objects from coming into contact with forklift cables, guide channels, rollers, lifting frame, or any other part of the mechanism where pinch points may occur causing injury.
- (i) A forklift which uses fuel such as propane or other gases should have the gas shut-off turned to the off position once the engine is stopped and the work completed.

MOTOR VEHICLES

- 8450.** Drivers of motor vehicles must obey local, state and/or federal motor vehicle codes. Operators and passengers of company owned, rented, or personal vehicles used for company service are required to wear their seat belts at all times while the vehicle is moving. Seat belts are not required to be worn in hi-rail vehicles on track. Company vehicles must be inspected for a properly maintained 5BC fire extinguisher or larger and a first-aid kit.
- 8451.** The vehicle driver is responsible for the safe and proper operation of the vehicle in his charge and the safety of the occupants. Except in unusual circumstances, it is the driver's responsibility to pay all fines, penalties, or charges that may be assessed for failure to comply with regulations.
- 8452.** When a vehicle is stopped and the employee is not at the controls, protect it against movement.
- 8453.** Only authorized people may operate or ride in company owned or leased vehicles. Privately owned vehicles may not be used while on duty without proper authority. The use of motorcycles while working is prohibited.
- 8454.** When on a highway, get in or out of vehicles from the side away from traffic, whenever practical. Always look to make sure it is safe to exit the vehicle.
- 8455.** When chains or non-skid devices are used, apply them to both of the single traction wheels. Apply them only to the outside wheel of dual wheels.
- 8456.** When driving at night, take the following precautions:
- (a) Slow down due to reduced visibility.
 - (b) Do not overdrive your headlights. Be able to stop within the distance illuminated by your headlights.
 - (c) Do not use your parking lights while your vehicle is in motion.
 - (d) When stopped, use four-way flashers.
- 8459.** When driving in adverse weather, take the following precautions:
- (a) Clean your windshield and windows. Remove ice, snow, and frost. Make sure the wipers and defroster are in good working condition.
 - (b) Adjust your speed accordingly. Slow down on wet, snowy, or icy roads.
 - (c) Get the feel of the road, test your brakes occasionally.
 - (d) Brake with gradually increasing pressure. Be aware that excessive braking may throw your vehicle into a skid.
 - (e) Follow at a safe distance. Be prepared for the vehicle ahead of you to stop unexpectedly.
- 8461.** Avoid backing up, if possible. Use "pull through" parking. When backing up a vehicle, make sure no obstructions are behind the vehicle to prevent safe movement. If there is more than one occupant, designate another person to stand near the rear of the vehicle and guide you as you back up. If the vehicle is not equipped with a back-up warning device, sound the horn once. Back up only the necessary distance.

8462. Unless vehicle is equipped with an external jumper plug and special cables, employees are to use roadside assistance for jumpstarting vehicles where practicable. If not practicable follow instructions in the owner's manual.

OPERATING SWITCHES

- 8500.** To operate a low switch stand or certain derails equipped with straight or weighted-type switch lever, observe the following guidelines:
- (a) Warn all others to clear moving parts and look to be sure that the switch stand, connecting rods, and open point space are free of obstruction.
 - (b) Make all movements with firm footing, secure handhold, and a braced position. Lift or push the lever steadily.
 - (c) Face the switch stand and place your feet clear of the lever, with the switch ball centered to your body.
 - (d) Keep your hand clear of switch target and keeper latch pinch points.
 - (e) Grip the end of the lever or ball while it is still latched (if equipped with a keeper) and push down to determine the degree of tension. Note: For switches with excessive tension stand upright and use your foot closest to the stand to release the keeper (staying clear of lever movement). Once the lever has stopped moving, reposition yourself to continue operating the switch.
 - (f) If tension feels to be within the normal range continue to maintain a secure handhold and use the foot closer to the stand to release the keeper latch, if so equipped with one.
 - (g) Raise the lever several inches and replace your foot firmly on the ground.
 - (h) Lift the lever up to the vertical position, using both hands, if necessary. Continually reposition yourself to keep the center of your body in line with the switch ball.
 - (i) Once the lever is vertical, begin a downward push towards the latch, repositioning your feet as the lever moves. Keep your feet clear of the ball as you push the lever down. Make sure that the keeper, if the stand is equipped with one, latches the lever.
 - (j) Check to be sure that the diverting switch point fits up properly before authorizing movement over it. If there is a derail, be sure that it is in proper position.

Note: While operating the switch, bend knees and keep your back straight. If you cannot follow the above steps, take precautions to operate the switch without incident. Report any defect to your immediate supervisor.

- 8501.** On certain switches, derails and other facilities equipped with a high stand, the operating lever hinges downward. This lever is parallel to a slot in the stand and is secured in that slot. The lever is raised to a horizontal position to operate. When operating such a lever, use the following procedure:
- (a) Warn all persons to clear moving parts. Be sure that the switch stand, connecting rods and open point space are free of obstruction.
 - (b) Make all movements with firm footing, secure handholds as close as possible to the end of the operating lever, and a braced position. Move the lever steadily.
 - (c) Keep your hand clear of the stand keeper slot, or other pinch point.
 - (d) Stand on the side of the switch ties on which the lever is latched to the switch stand.
 - (e) At arm's length, using your palm only, slowly lift the lever out of the keeper slot and allow it to completely release any tension. If the tension feels to be within normal range, raise the handle to the horizontal position.
 - (f) Face the switch stand, place one foot against the side of the headblock to which the lever will be moved. Place the other foot between the headblocks and against the side of the farther tie.
 - (g) Pull the lever as far as possible without interfering with your braced position.
 - (h) Move to the side of the headblock to which the lever will be latched to the switch stand. Place one foot against the side of the timber and finish pulling the lever so it will be in line with the latch slot below.
 - (i) Lower the lever into the keeper slot. Do not use your foot to push the lever.
 - (j) Be sure that the diverting switch point fits up properly before you authorize movement over it. Be sure that the derail, if there is one, is in the proper position.

Note: Should the physical characteristics of the switch or any other factor make it impractical to follow any of the precautions above, take precautions to operate the switch without incident. Report any defects to your immediate supervisor.

Appendix A Material Weights for Lifting & Transporting Chart

The following charts must be complied with when lifting or transporting:

MATERIAL WEIGHTS FOR LIFTING & TRANSPORTING					
<p>Know your weight prior to attempting a lift. Use this load chart to determine: (a) The maximum boom radius, or (b) the minimum boom angle All outriggers/stabilizers must be firmly set. Assure yourself that the lift can be made safely. Re-stow the boom properly before departure. Know your GVW, axle weights and height.</p>					
TRACK MATERIAL					
1.	High quality, thick wall 132/136 lb. Railbound				
	Manganese Frogs	#8	#10	#15	#20
	(a) Standard Design: (Initial Installation)	2850 lbs.	4925 lbs.	5600 lbs.	6300 lbs.
	(b) Extended Leg: (Maintenance Replacement)	3150 lbs.	5200 lbs.	5850 lbs.	6600 lbs.
2.	Railbound Manganese Frogs (Not high quality, thick wall)				
		#8	#10	#15	#20
	132 lb.	2680 lbs.	3315 lbs.	4250 lbs.	5450 lbs.
	140 lb.	2750 lbs.	3400 lbs.	4400 lbs.	5500 lbs.
	155 lb.	2900 lbs.	3600 lbs.	4600 lbs.	6000 lbs.
3.	Guard Rail: Braced Hook Flange		9 ft.	850 lbs.	
			13 ft.	1050 lbs.	
4.	Self Guarded Frogs:		#8	#10	
	119 lb.	1600 lbs.	1740 lbs.		
	132 lb.	1750 lbs.	1930 lbs.		
5.	Switch Points	Bolted T. O.		Welded T. O.	
		132 lb.		132 lb.	136 lb.
		16'6"	1140 lbs.	27'0"	1175 lbs.
		26'0"	1500 lbs.	38'0"	1850 lbs.
		39'0"	1920 lbs.	59'6"	2750 lbs.
6.	60 Foot Stock Rail:		132 lb.	2640 lbs.	
		136 lb.	2720 lbs.		
7.	39 Foot Rail:		119 lb.	1550 lbs.	136 lb.
		127 lb.	1650 lbs.	140 lb.	1820 lbs.
		132 lb.	1720 lbs.	155 lb.	2020 lbs.
8.	Spikes		Track (Including keg) 210 lbs.		
			Screw (Including keg) 210 lbs. (Pandrol & switch plate)		
			Drive Lags (Per box) 250 lbs. (Highway crossing)		
9.	Track Bolts: (Including keg)		210 lbs.		
10.	Rail Anchors: Bag of 50		150 lbs.		

TRACK MATERIAL – Continued						
11.	Pandrol Clips: Bag of 50		100 lbs.			
12.	Joint Bars:		(Weight per bar)			
	119 lb.		54 lbs.			
	127, 132, 136 or 140 lb.		60 lbs.			
	152 or 155 lb.		72 lbs.			
13.	Continuous Insulated Joint:					
	6 hole, 127 thru 140 lb. complete		180 lbs.			
14.	Compromise Joint: Pair of 2 bars – representative weights.					
	155 PS	132 RE, 6 hole	125 lbs.			
	140 RE	127 DM, 6 hole	120 lbs.			
	130 PS	100 PS, 4 hole	75 lbs.			
15.	Tie Plate: Type 1 – 7” x 10” single shoulder		13 lbs.			
	7 ¾” x 14 ¾” heavy duty, double shoulder		24 lbs.			
	7 ¾” x 15”, Resilient (Pandrol)		25 lbs.			
16.	Cross Ties: 6” (6” x 8” x 8’6”)		190 lbs.			
	7” (7” x 9” x 8’6”)		250 lbs.			
17.	Sample Stacks of Cross Ties:					
	6 each of 6”	1150 lbs.	9 each of 7”	2250 lbs.		
	6 each of 7”	1500 lbs.	12 each of 6”	2300 lbs.		
	9 each of 6”	1700 lbs.	12 each of 7”	3000 lbs.		
18.	Switch Timber: (7” x 9” x Length)				15 ft.	435 lbs.
	9 ft.	260 lbs.	12 ft.	350 lbs.	16 ft.	465 lbs.
	10 ft.	290 lbs.	13 ft.	375 lbs.	21 ft.	610 lbs.
	11 ft.	320 lbs.	14 ft.	405 lbs.	22 ft.	640 lbs.
19.	Crossing Timbers:					
	“A” – Inside Single		– Highway or Farm			
	“B” – Outside Double		– Highway Crossing			
	“C” – Outside Single		– Farm Crossing			
	1A (8 5/8” high)	315	1B	630 lbs.	1C	315 lbs.
	2A (7 5/8” high)	295	2B	590 lbs.	2C	295 lbs.
	4A (7 ½” high)	275	4B	550 lbs.	4C	275 lbs.
	5A (6 ½” high)	240	5B	480 lbs.	5C	240 lbs.
20.	Corrugated Pipe:		6” Diameter	16 Gauge	5 lb. per ft.	
			12” Diameter	14 Gauge	12 lb. per ft.	
			18” Diameter	14 Gauge	18 lb. per ft.	
21.	Switch Stand:		New Century	190 lbs		
			Automatic Model 22	205 lbs.		

TRACK MATERIAL – Continued					
	Notes:				
1.	Drums of Anchors, Bolts or Spikes:				
	Estimate the number of bags or kegs in the drum and multiply by 150 lbs. per bag or 200 lbs. per keg. Add 45 lbs. for the drum.				
2.	Material Weight Not Shown:				
	Use the next higher weight in the table for the type of material being handled.				
B&B MATERIAL					
1.	Bridge Timber: Find weight per lineal foot below and multiply by the length in feet. Add 30 lbs. for each set of two spacer blocks.				
		9" x 10"	= 42 lbs. per lineal foot		
		9" x 12"	= 50 lbs. per lineal foot		
		9" x 13"	= 54 lbs. per lineal foot		
		12" x 12"	= 66 lbs. per lineal foot		
		12" x 14"	= 77 lbs. per lineal foot		
	Note: Use the following formula to calculate the weight of all other treated oak: Multiply the number of BOARD FEET by 5.5 lbs. BOARD FEET = Thickness (in.) x width (in.) x Length (ft.) divided by 12				
2.	Treated Pine: Board Feet x 4.6 lbs				
3.	Plywood: 4' x 8' Sheets	3/8"	= 35 lbs.		
		1/2"	= 46 lbs.		
		5/8"	= 55 lbs.		
		3/4"	= 66 lbs.		
4.	Spacing Bars: (Bridge Timber)	125 lbs. each			
5.	Walking Grating: (Bridge)	24" x 20"	= 400 lbs. each		
		30" x 20"	= 500 lbs. each		
		36" x 20"	= 600 lbs. each		
6.	Tie Pads: 185 lbs. per 100 pads or 1950 lbs. per pallet of 1000 pads. (Includes 100 lbs. for weight of pallet)				
7.	Reinforcing Bars: (Rebars)	Size	Diameter	Wt. per Ft.	Wt. per 20'
		#2	1/4"	0.2 lbs.	4 lbs.
		#3	3/8"	0.4 lbs.	8 lbs.
		#4	1/2"	0.7 lbs.	14 lbs.
		#5	5/8"	1.0 lbs.	21 lbs.
		#6	3/4"	1.5 lbs.	30 lbs.
		#7	7/8"	2.0 lbs.	41 lbs.
		#8	1"	2.7 lbs.	54 lbs.

B&B MATERIAL – Continued

B&B MATERIAL – Continued					
8.	Steel Plate:	Thickness	Wt. per Sq. Ft.	Wt. per 4' x 8' Sheet	
		1/8"	5.1	163 lbs.	
		1/4"	10.2	326 lbs.	
		3/8"	15.3	489 lbs.	
		1/2"	20.4	652 lbs.	
		5/8"	25.5	815 lbs.	
		3/4"	30.6	978 lbs.	
		7/8"	35.7	1141 lbs.	
		1"	40.8	1304 lbs.	
Other Dimensions: Thickness (in.) x Width (in.) x Length (in.) x 0.283 = Weight					
9.	Perforated Drain Pipe:	Diameter	Wt. per Ft.	Wt. per 20' Length	
		6" – 16 Ga.	5 lbs.	100 lbs.	
		12" – 16 Ga.	10 lbs.	200 lbs.	
		12" – 14 Ga.	13 lbs.	260 lbs.	
		18" – 14 Ga.	19 lbs.	380 lbs.	
		24" – 14 Ga.	25 lbs.	500 lbs.	
		24" – 12 Ga.	35 lbs.	700 lbs.	
10.	Corrugated Culvert:	Galvanized		Coated	
	Size	Wt. per Ft.	Wt. per 20'	Wt. per Ft.	Wt. per 20'
	24" – 16 Ga.	20 lbs.	400 lbs.	24 lbs.	480 lbs.
	24" – 14 Ga.	24 lbs.	480 lbs.	29 lbs.	580 lbs.
	36" – 16 Ga.	29 lbs.	580 lbs.	36 lbs.	720 lbs.
	36" – 14 Ga.	36 lbs.	720 lbs.	43 lbs.	860 lbs.
	48" – 16 Ga.	38 lbs.	760 lbs.	48 lbs.	960 lbs.
	48" – 14 Ga.	48 lbs.	960 lbs.	58 lbs.	1160 lbs.
	60" – 14 Ga.	60 lbs.	1200 lbs.	71 lbs.	1420 lbs.
	60" – 12 Ga.	81 lbs.	1620 lbs.	92 lbs.	1840 lbs.
	60" – 10 Ga.	103 lbs.	2060 lbs.	114 lbs.	2280 lbs.
11.	Iron Pipe:	Standard Weight		Extra Strong	
	Diameter	Wt. per Ft.	Wt. per 21'	Wt. per Ft.	Wt. per 21'
	1/2"	0.9	19 lbs.	1.1	23 lbs.
	3/4"	1.2	25 lbs.	1.5	31 lbs.
	1"	1.7	36 lbs.	2.2	46 lbs.
	1-1/4"	2.3	48 lbs.	3.0	63 lbs.
	1-1/2"	2.7	57 lbs.	3.7	78 lbs.
	2"	3.7	78 lbs.	5.0	106 lbs.
12.	Handrail Post: 25 lbs. each				
13.	Mixed Concrete: Approx. 2 Ton per cubic yard				
Notes: 1. Structural Steel: Weights for I-beams, H-piling, Sheet Piling, Channels, Angels, etc. can be obtained from the supplier or "Supervisor's "Steel Handbook".					
2. Lumber not listed: Have the supplier supply the weight.					
3. Palletized Materials: Add 100 lbs. for the weight of the pallet.					

C&S MATERIAL

C&S MATERIAL									
1.	Batteries: (unpacked)			2. Case-Relay-Corten: (empty)					
	EMF-80	20 lbs.		Low Sgl. 31"	295 lbs.				
	EMF-120	26 lbs.		Low Sgl. 41"	355 lbs.				
	DMP-9	35 lbs.		High Sgl.	415 lbs.				
	EMF-210	42 lbs.		High Dbl.	665 lbs.				
	EMF-265	52 lbs.		Sgl 56"h x 39"w x 24"d	500 lbs.				
	EMF-9	66 lbs.		Sgl 76"h x 39"w x 24"d	500 lbs.				
	EMP-13	92 lbs.		Dbl 76"h x 81"w x 24"d	1000 lbs.				
			Dbl 80"h x 81"w x 24"d	1100 lbs.					
3.	Battery Box Foundations:			4. Cantilever. Highway			5. House-Corten		
	Jr.	20" x 24" ID	390 lbs.	Arm & Mast, 18'	1005 lbs.	6' x 8'	Empty	1950 lbs.	
	Sm.	22" x 33" ID	598 lbs.	Arm & Mast, 22'	1152 lbs.	8' x 8'	Empty	2940 lbs.	
	Med.	33" x 49" ID	913 lbs.	Arm & Mast, 26'	1279 lbs.	8' x 10'	Empty	3410 lbs.	
6.	Cable/Wire per 1000' on Reel			Gate mech, Combo	325 lbs.	8' x 12'	Empty	3950 lbs.	
	2C	#6	334 lbs.	Gate mech, RD or SD Walk	300 lbs.	8' x 14'	Empty	4520 lbs.	
	5C	#9	431 lbs.	(S-1) 3'6"	710 lbs.	8' x 16'	Empty	5010 lbs.	
	7C	#9	537 lbs.	(S-2) 4'6"	1290 lbs.	8' x 18'	Empty	5550 lbs.	
	19C	#14	650 lbs.	(S-2) 5'6"	1486 lbs.	8' x 20'	Empty	6080 lbs.	
	27C	#14	916 lbs.	(S-2) 6'6"	1682 lbs.	8' x 22'	Empty	6688 lbs.	
	37C	#14	1158 lbs.	1650 lbs each, Top	1200 lbs.	8' x 24'	Empty	7296 lbs.	
	25 Pr Comm		1080 lbs.	12" Spider (each)	285 lbs.				
	15 C Comp-3C #8		751 lbs.	(S-19) 4 sec base:					
	12C #14			2550 lbs each, Top	2360 lbs.				
	15 C Comp-5C #6		1248 lbs.	8" Spider (each)	190 lbs.				
	10C #12								
	7.	Poles			8. Cross Arms			9. Retarder Components	
Length		CL		6' - 25 lbs.		E-160 mechanism without motors and operating bars	2200 lbs.		
25'		5	490 lbs.	10' - 40 lbs.					
30'		5	661 lbs.	10. Switch Machines					
35'		5	844 lbs.	Make	Model		E-160 motor	500 lbs.	
40'		5	1049 lbs.	GRS	6HS	800 lbs.	E-160 operating bar	225 lbs.	
45'		5	1265 lbs.	GRS	5A & 5E	900 lbs.	Inert Beam (GRS P71-552)	1000 lbs.	
50'		5	2018 lbs.	GRS	5B, 5C,	1100 lbs.	Beam L&R (P71-550/P71-551)	500 lbs.	
65'		5	2945 lbs.	GRS	5D, 5F				
				GRS	5G		Beam Shoe, intermediate	700 lbs.	
			US&S	5A (air)	1000 lbs.	Cross Bar	450 lbs.		
			US&S	M2 & M3	800 lbs.	Channel, 7 hole	1000 lbs.		
			US&S	23B	900 lbs.	Channel, 8 hole	1200 lbs.		
			US&S	T-20	400 lbs.	Angle, 7 hole	1900 lbs.		
						Angle, 8 hole	2000 lbs.		
						Operating Bar, 4 hole	700 lbs.		
						Operating Bar, 7 hole	1200 lbs.		
						Cyl. Unit assembly, Models 31, 31A, 32, 66, 67 * 81	1800 lbs.		

Handling Materials with Grapples

Material	Grapple Type		
	By-Pass	Butt	Thumb
Ties and Timber	Yes	Yes	Yes
Crossing Material	Yes	Yes	Yes
Filter Fabric (Rolls)	Yes	Yes	Yes
Palletized Material	Yes	Yes	No
Signal Foundations - Palletized	Yes	Yes	No
Debris	Yes	Yes	Yes
Rail	Yes	Yes	Yes
Switch Points	Yes	Yes	Yes
Frogs	Yes	Yes	Yes
Grating	Yes	Yes	No
Pipe	Yes	Yes	Yes
Kegs	Yes	Yes	Yes
OTM – Bagged	Yes	Yes	Yes
Signal Masts	Yes	Yes	No
Retarder Parts	Yes	Yes	No

SPECIAL HANDLING

Items below may be handled only with an intermediate sling and the listed devices

MATERIAL	GRAPPLE TYPE		
	By-Pass	Butt	Thumb
Compressed Gas Cylinders	Cylinder Tote or Platform		No
Barrel	Barrel Handle or Sling		No
Small Machinery Equipment Ramps Signal Cases & Bungalows	Sling Only		
Cable Reels	Spinner (reel thing) or Reel Sling		No

Grapple Types

By-Pass (Timber Grab)

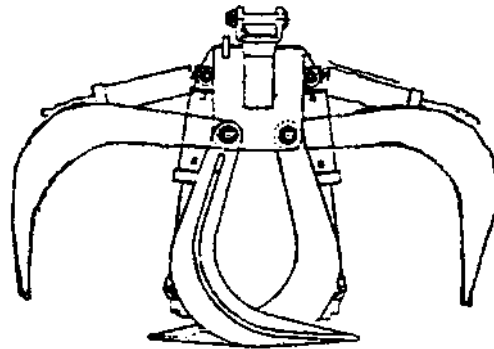

Butt (Multi-purpose Grab)

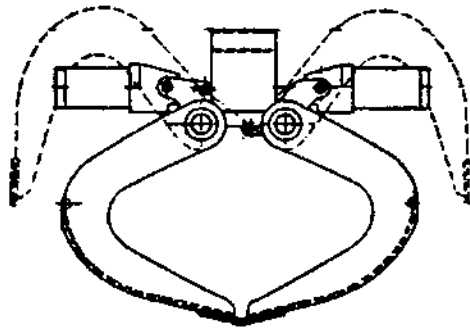

Thumb (One side fixed, other side moveable)

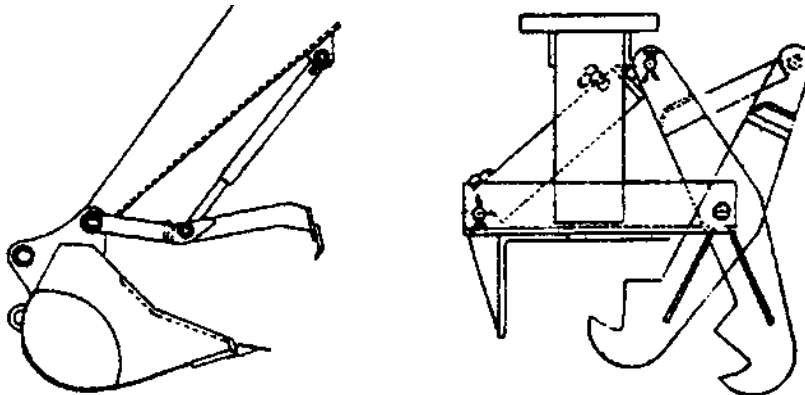

Handling Procedures

1. Assure yourself that the lift can be made safely. Warn others to remain clear of the load.
2. Know the weight to be lifted prior to attempting the lift.
3. Use the load chart to determine the maximum broom radius.
4. All outriggers must be firmly set.

Appendix B Chain Saw Use Decision Matrix

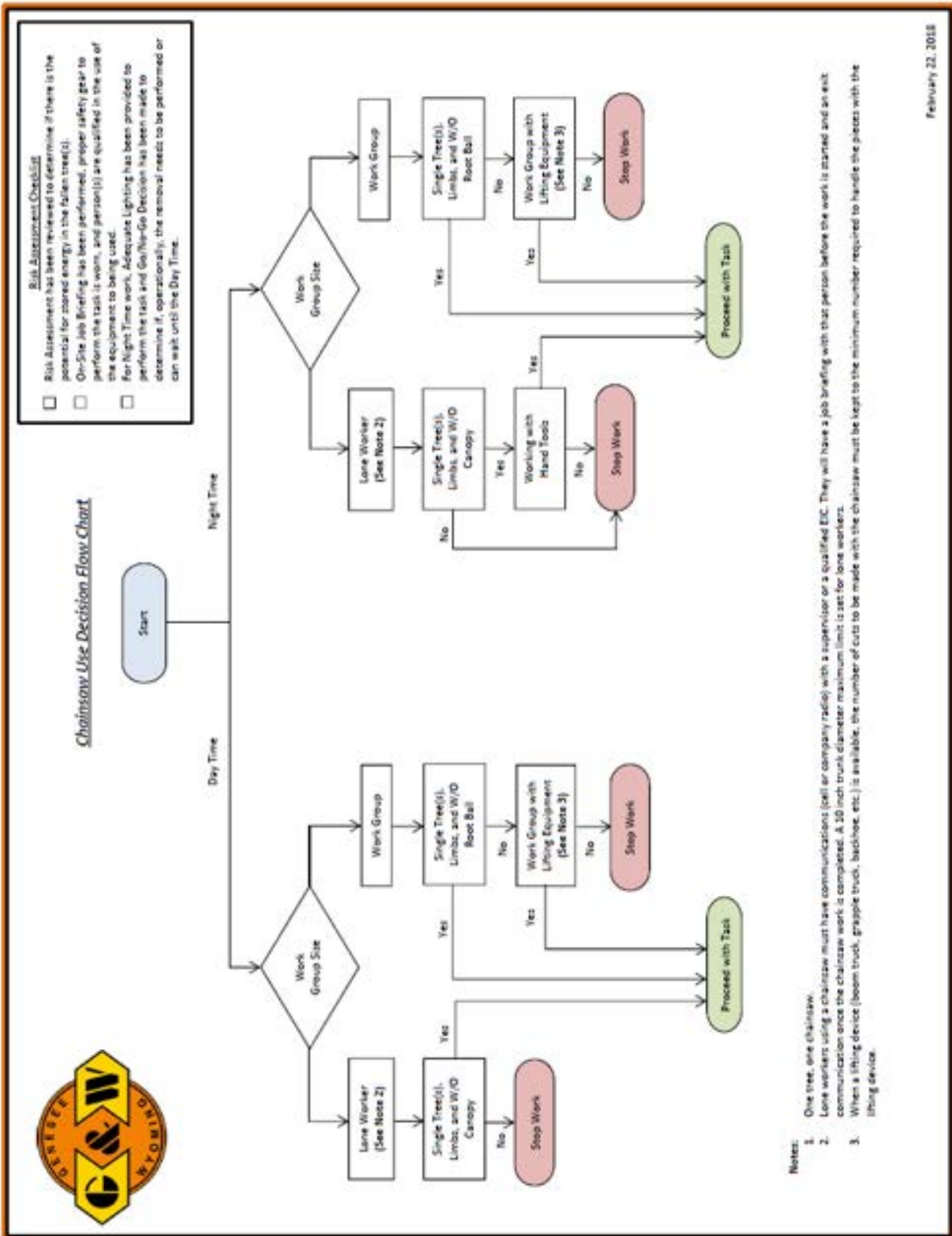

Appendix C Safety Rule Calendar

Annual Safety Rule Calendar						
ENGINEERING EMPLOYEES						
THE SAFE WAY MUST BE THE ONLY WAY						
Accident prevention starts by knowing, understanding and practicing correct procedures whenever you perform any task.						
Date	January	February	March	April	May	June
1	5	8198	8428	11	8120	8352
2	17	8007	8008	8160	8086	8420
3	8004	8126	8070	8210	8052	8230
4	1	8225	8211	8351	8429	5
5	8000	8332	13	8403	8333	21
6	8138	8081	8051	8127	8092	8213
7	8400	8353	8088	8418	8133	8031
8	8450	8071	8190	18	8432	8302
9	8050	8104	4	8003	8191	8109
10	8150	8307	8059	8234	8087	8004
11	8461	8311	8153	8059	8101	8159
12	8404	14	8030	8212	8137	8102
13	8002	8421	8158	8150	8430	8220
14	8180	8122	8331	8183	7 and 8057	8123
15	8350	8181	8156	8054	8231	8228
16	8417	8085	8005	8100	8452	8433
17	8338	8140	8408	8196	8053	8009
18	8052	8223	8451	8083	8128	8334
19	8011	8136	8105	8151	8312	8224
20	8182	8053	8129	8217	8226	8121
21	8054	8192	8135	8106	8232	8055
22	8057	8357	8082	8138	8084	8222
23	8103	8131	8124	8380	8193	8152
24	8423	8154	8354	8381	8232	8358
25	8080	8093	8134	8059	8107	8195
26	8083	8194	8434	26	8215	8422
27	8125	8155	8091	8094	8355	8221
28	8300	8214	8309	8108	8419	8450
29	8455	x	8157	8139	8219	8132
30	8130	x	8184	8218	8227	8310
31	8221	x	8197	x	8223	x

Annual Safety Rule Calendar

ENGINEERING EMPLOYEES

THE SAFE WAY MUST BE THE ONLY WAY

Accident prevention starts by knowing, understanding and practicing correct procedures whenever you perform any task.

Date	JULY	AUGUST	SEPTEMBER	OCTOBER	NOVEMBER	DECEMBER
1	8088	8126	8335	8301	11	8220
2	1	8198	8424	8210	8101	8302
3	8404	8417	8135	8405	8120	8303
4	8089	8104	8428	8418	8337	8004
5	8194	8300	13	12	8454	8332
6	8000	9	8191	24	8359	8409
7	8197	8401	8134	8100	8429	8102
8	23	8007	8001	8127	8080	8153
9	8004	8182	8211	19	8030	8431
10	8103	8315	8056	8121	8133	8402
11	8155	8423	8071	8351	8501	8183
12	8305	8156	8058	8129	9	8217
13	8002	14	8216	8406	8002	8314
14	8138	8181	8304	8003	8052	8352
15	8080	8190	8139	8000	8459	8420
16	8400	8440	8051	8151	8419	8056
17	8050	8055	8132	8403	8084	8009
18	8180	8053	8154	8054	8070	8226
19	8353	8357	4	8316	8086	16
20	2	8140	8413	8106	8137	8055
21	8125	8081	8031	8426	8312	8123
22	8414	8157	25	8050	7	8195
23	8461	8160	8192	8083	8331	8435
24	8057	8122	8082	8005	8380	19
25	8130	8196	8124	8158	8381	8159
26	8150	8225	8434	8500	8092	8410
27	8184	8093	8336	8087	8105	8462
28	8311	8131	8152	8108	8356	25
29	8350	8058	8128	8	8107	8003
30	8427	8085	8091	26	8215	8056
31	8086	8136	x	8094	x	8416